

Cub Cadet

Cub Cadet

ENDURO SERIES

FORCE SERIES

PRO SERIES



You can find the current prices (RRP) on our website at pricelist.cubcadet.eu
Or open the file directly with the QR code.

Stanley Black & Decker Outdoor GmbH
Wiesenstraße 9 • 66129 Saarbrücken • GERMANY

Germany
Phone +49 (0)681 96 98 90 69
cubservice.de@mtdproducts.com

Austria
Phone +43 (0)720 81 60 88
cubservice.at@mtdproducts.com

Switzerland
Phone +41 (0)43 58 81 35 9
cubservice.ch@mtdproducts.com

www.cubcadet.eu

© 2022 Stanley Black & Decker Outdoor GmbH, Germany. All rights reserved. Cub Cadet and other trademarks are registered trademarks of Stanley Black & Decker. For more information, simply go to our website: www.cubcadet.eu. We reserve the right to make changes to prices, technical features and changes due to printing and other errors.

As of 08/2022



**PRODUCT
RANGE 2023**

OUR CUB CADET HIGHLIGHTS FOR 2023

Once again this year, you can expect numerous new products in the Cub Cadet range as well as innovative enhancements to existing product series.

In 2023, the new electric Zero-Turn XZ5 EL107 will join the family of our battery-powered workhorses. This means that in future you will also be able to work with our most manoeuvrable series in operation without emissions and mow even large areas quietly and with the power you are expecting from Cub Cadet.

Read more on page 18.

NEW



XZ5

ENDURO SERIES®

ELECTRIC
LITHIUM ION



NEW

XZ8

ENDURO SERIES®

Our new ULTIMA-Zero-Turns XZ8 S122 ULTIMA and XZ8 S137i ULTIMA convince not only with their Synchro Steer® Technology for hilly terrains but also with strength in construction.

Read more on page 64.

Image similar

StanleyBlack&Decker

LAST BUT NOT LEAST:

Cub Cadet has been part of the large, globally active Stanley Black & Decker family since 2022. With established brands, even more opportunities for joint growth and a strong partnership – now and in the future.



LT

FORCE SERIES

The petrol-powered LT tractor series has been given a modern design and now comes with new technical features.

Read more on page 40.



XR5

ENDURO SERIES®

For those who don't want to mow themselves, we recommend the XR5 series robotic mowers. They care for lawns of up to 4,000 m² and, with their sophisticated technical equipment, do not shy away from even the most demanding terrains.

Read more on page 4.

THE XR5 IS DEVELOPED TO DELIVER QUALITY TIME AND TIME AGAIN, TO GIVE YOUR LAWN THAT FLUFFY LOOK.



THE GARDENING ASSISTANT YOU'VE BEEN LOOKING FOR

The XR5 has been developed to cut your lawn that your neighbour will think you have cut it yourself. The high quality steel blades cut your grass for health and thickness so you get a luscious lawn with the time back to actually enjoy it.



1. BEAUTIFULLY FINISHED EDGES

Cutting beyond the edge of the wheel, the XR5 gives you a finish to be proud of, even on uneven surfaces.



2. HANDLES THICK GRASS AND UNEVEN TERRAIN

The XR5 is designed to handle uneven terrain and keep the lawn freshly cut and good looking.



3. EASY TO USE

From our easy to use interface and other features, including the charging station, Cub Cadet makes the XR5 quick and easy to install.



4. EASY TO MAINTAIN

XR5 has been developed to self-clean, giving you more time in the garden. For complete peace of mind, you should arrange an annual maintenance service with your dealer.

FLOATING DECK

SELF CLEANING DECK AND WHEELS

360 DEGREE SENSOR



DISCOVER THE XR5!

EDGE MODE TECHNOLOGY

SPECIALLY DESIGNED CUTTING SYSTEM

4.3" TOUCHSCREEN

SLOPE HANDLING TECHNOLOGY

HIGH TRACTION WHEELS FOR UNEVEN TERRAIN

XR5 MOWING IN A CLASS OF THEIR OWN

XR5 ENDURO SERIES®

From floating deck and slope handling to beyond-the-wheel edge cutting mode, the Cub Cadet XR5 range is packed with features that give your lawn a beautiful finish. The double mowing deck models are designed for lawn areas of up to 3000/4000 m² while their smaller siblings are for 1000/2000 m². All XR5s models are eligible for 1 free year additional warranty** – protection against theft and vandalism included.



XR5 1000	
Cutting width:	21 cm
Cutting height:	20-100 mm
Lawn area (rec.):	Up to 1.000 m ² *
Mowing time (per charge):	40-50 min
Engine:	DC Brushless
Power consumption:	4,0 kWh/month
Model no.:	22AKFEFA603

XR5 2000	
Cutting width:	21 cm
Cutting height:	20-100 mm
Lawn area (rec.):	Up to 2.000 m ² *
Mowing time (per charge):	80-90 min
Engine:	DC Brushless
Power consumption:	7,3 kWh/month
Model no.:	22AKHEFA603



DOUBLE DECK WITH 42 CM CUTTING WIDTH

XR5 3000	
Cutting width:	42 cm
Cutting height:	20-100 mm
Lawn area (rec.):	Up to 3.000 m ² *
Mowing time (per charge):	80-90 min
Engine:	DC Brushless
Power consumption:	8,7 kWh/month
Model no.:	22AKJEFA603

XR5 4000	
Cutting width:	42 cm
Cutting height:	20-100 mm
Lawn area (rec.):	Up to 4.000 m ² *
Mowing time (per charge):	110-120 min
Engine:	DC Brushless
Power consumption:	11,5 kWh/month
Model no.:	22AKLEFA603

*Max. mowing area under ideal mowing conditions: flat level lawn, simple rectangular shape, no obstacles, no additional zones, and modest lawn growing pace.

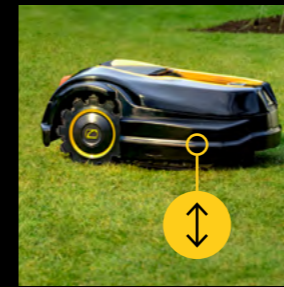

1. FLOATING DECK
Designed even for uneven lawns it provides a beautiful finish.



2. SLOPE HANDLING
45% slope handling performance makes light work of challenging lawn setups.



3. 100 MM CUTTING HEIGHT
Tall, thick grass is not a problem with a 100 mm maximum cutting height.



4. PATENTED HIGH TRACTION WHEELS
The patented wheels deliver high traction and a smooth drive.



5. LOW NOISE
Thanks to its drive motor, the XR5 mows quiet.



6. SELF-CLEANING
Self cleaning deck and wheels, making maintenance a breeze.



7. 4.3" TOUCHSCREEN
Set your mower to the exact setting you want with an easy-to-use 4.3" LCD touchscreen.



8. EDGE MODE TECHNOLOGY
The XR5's edging ability mows beyond the wheel to help deliver a precise finish every time.



9. PATENTED CUTTING SYSTEM
Thanks to its patented cutting system you can have a great cut.



10. 360 DEGREE SENSOR
The XR5's omni-directional obstruction sensor helps it navigate around obstacles (please still make sure that there are no children or pets on the lawn while mowing).

3 YEARS**
Cub Cadet
WARRANTY

FREE 1-YEAR EXTENDED WARRANTY
available!
For more information visit www.cubcadet.eu

** Manufacturer's warranty from Stanley Black & Decker Outdoor GmbH, limited to supplementary performance and according to the warranty conditions (available at www.cubcadet.eu).

Images partly show previous year's models

COMPLETE CONTROL VIA SMARTPHONE

The App allows the robotic mowers in the XR ENDURO SERIES to be controlled and programmed conveniently using your smartphone. Equipped with a supporting industry standard for optimal connectivity. Simply download the app, install it on your phone and get mowing.

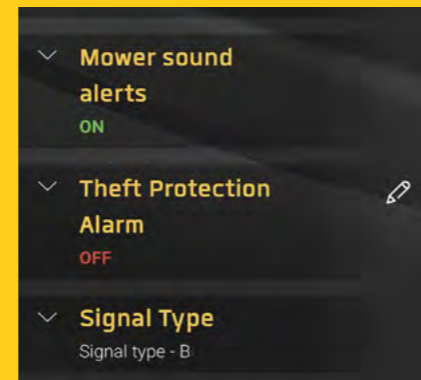
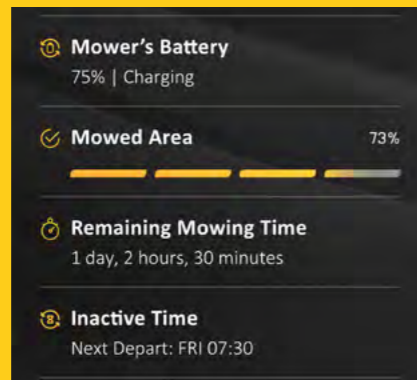
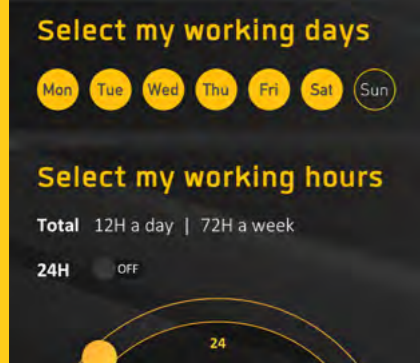

CONTROL

- Set mowing schedule
- Manage multiple zones
- Send to mow
- Return to base
- Manual drive
- Theft protection

INFO

- Mowing history
- Mowed area
- Departure times
- Remaining mowing time

ADVANCED

- Operational alerts*
- GEO-FENCE - Trace your mower in case of theft

*Subject to your approval

ROBOTIC MOWER ACCESSORIES









PERIMETER SETTING			
	Perimeter wire (650 metres on spool)		Mod. no.: MRK0067B
	Installation Kit small (for max. 400 m²) 100 m wire, 150 pegs		Mod. no.: 122-001-603
	Installation Kit medium (for max. 1.200 m²) 150 m wire, 200 pegs		Mod. no.: 122-002-603
	Installation Kit large (for max. 2.500 m²) 250 m wire, 350 pegs		Mod. no.: 122-003-603
REPLACEMENT BLADES			
	Blade kit XR5 models		Mod. no.: 122-105-603
COVERS			
	RoboHome for XR5 models		Mod. no.: 122-085-603



TABLE OF PRODUCTS

	XR5 1000	XR5 2000
BATTERY		
Engine	DC Brushless	DC Brushless
Battery	18,15V Li-Ion	18,15V Li-Ion
Mowing time (per charge)	40-50 min	80-90 min
Charging time	60-120 min	60-120 min
Power consumption	4,0 kWh/month	7,3 kWh/month
CUTTING SYSTEM		
Lawn area (rec.)	Up to 1.000 m ² *	Up to 2.000 m ² *
Cutting width	21 cm	21 cm
Cutting height (min.-max.)	20-100 mm	20-100 mm
Blades	4 cutting blades	4 cutting blades
Spare blades	8	12
Mowing zones	1 main zone, 4 sub zones, separate zones	1 main zone, 4 sub zones, separate zones
Area coverage per hour	65 m ² /h	65 m ² /h
Maximum inclination	24° / 45 %	24° / 45 %
EQUIPMENT		
Base station	Included	Included
RoboHome	Optional (122-085-603)	Optional (122-085-603)
Display	4,3" HD coloured touch	4,3" HD coloured touch
App	Standard	Standard
Anti-theft	Standard	Standard
Bump-Sensor	360° detection	360° detection
Tilt-Sensor	Standard	Standard
Lift-Sensor	Standard	Standard
Edge mode	Standard	Standard
GSM modul	Standard	Standard
Wheels	Patented HIGH TRACTION wheels	Patented HIGH TRACTION wheels
DIMENSIONS		
Noise level LpA/LwA/LwAg	50/61/64 dB (A)	50/61/64 dB (A)
Dimensions (L/W/H)	66,3 / 50,7 / 28,5 cm	66,3 / 50,7 / 28,5 cm
Package dimensions (L/W/H)	82 / 54 / 32 cm	82 / 54 / 32 cm
Weight (net / incl. packaging)	10,5 / 18,5 kg	10,5 / 18,5 kg
Model number		
	22AKFEFA603	22AKHEFA603
EAN		
		

	XR5 3000	XR5 4000
BATTERY		
Engine	DC Brushless	DC Brushless
Battery	18,15V Li-Ion	18,15V Li-Ion
Mowing time (per charge)	80-90 min	110-120 min
Charging time	60-80 min	90-110 min
Power consumption	8,7 kWh/month	11,5 kWh/month
CUTTING SYSTEM		
Lawn area (rec.)	Up to 3.000 m ² *	Up to 4.000 m ² *
Cutting width	42 cm	42 cm
Cutting height (min.-max.)	20-100 mm	20-100 mm
Blades	2 x 4 cutting blades	2 x 4 cutting blades
Spare blades	16	24
Mowing zones	1 main zone, 4 sub zones, separate zones	1 main zone, 4 sub zones, separate zones
Area coverage per hour	135 m ² /h	135 m ² /h
Maximum inclination	24° / 45 %	24° / 45 %
EQUIPMENT		
Base station	Included	Included
RoboHome	Optional (122-085-603)	Optional (122-085-603)
Display	4,3" HD coloured touch	4,3" HD coloured touch
App	Standard	Standard
Anti-theft	Standard	Standard
Bump-Sensor	360° detection	360° detection
Tilt-Sensor	Standard	Standard
Lift-Sensor	Standard	Standard
Edge mode	Standard	Standard
GSM modul	Standard	Standard
Wheels	Patented HIGH TRACTION wheels	Patented HIGH TRACTION wheels
DIMENSIONS		
Noise level LpA/LwA/LwAg	50/61/64 dB (A)	50/61/64 dB (A)
Dimensions (L/W/H)	66,3 / 53,0 / 28,5 cm	66,3 / 53,0 / 28,5 cm
Package dimensions (L/W/H)	82 / 54 / 32 cm	82 / 54 / 32 cm
Weight (net / incl. packaging)	12,2 / 20,5 kg	12,2 / 20,5 kg
Model number		
	22AKJEFA603	22AKLEFA603
EAN		
		

ELECTRIFYING EXPERIENCES IN SERIES

Your lawn care depends on strong equipment, and our electric lineup won't let you down. Each piece is engineered with the same uncompromising commitment to design, comfort and performance we demand from every product.



LONG RUNTIME



LOW CHARGE TIME



LOW NOISE



LESS MAINTENANCE THAN GAS

NEW



LR2
FORCE SERIES

MOWING WITH POWER WHILE RESPECTING THE ENVIRONMENT

Our MINI-RIDER LR2 ES76 uses strong electric motors and is powered by a 56V Li-ION battery. Its large cutting width of 76 cm combined with 60 minutes* of running time (per charge) make the cutting of large lawns easy. And it comes with a 3 year warranty on both the mower and the battery.



Learn more

MOWING TIME 60 MIN*
4 HOURS CHARGING TIME



LR2 ES76	
Cutting width:	76 cm
Area performance (rec.):	3.000 m ² /h
Collecting volume:	Optional 115 l
Engine:	Cub Cadet 56 V / 30 Ah / 1.500 Wh
Drive:	Electric drive
Cutting height adjustment:	5 positions
Model no.:	33BA27JD603

*When fully charged. Deviations are possible depending on lawn and weather conditions, and grass thickness.

COMFORTABLE CUT & SEW SEAT WITH TOOL-LESS SEAT ADJUSTMENT

ZERO EMISSIONS DURING YOUR WORK

OPTIONAL 115 L GRASS CATCHER

BRIGHT LED HEADLIGHTS High visibility even when working at dawn or dusk.

MAINTENANCE- AND SERVICE-FRIENDLY

VARIABLE SPEEDS WITH FOOT PEDAL CONTROL

FRONT BUMPER

RETURN-FUNCTION At a battery level of 10 %, the cutting deck automatically switches off help saving power to return to the charging station.

MOW-IN-REVERSE The Reverse Mowing Technology allows you to continue mowing while driving backwards (must be activated manually).

56V LI-ION POWER



Li-Ion
ELECTRIC

XT2
ENDURO SERIES®



LI-ION-POWER

Modern battery technology helps provide a long service life as well as speedy charging cycles – once hooked up to an outlet, the battery is fully recharged within 4 hours.



Learn more

MOWING TIME 90 MIN*
4 HOURS CHARGING TIME



XT2 ES107	
Cutting width:	107 cm
Area performance (rec.):	8.000 m ² /h
Collecting volume:	Optional 200 l
Engine:	Cub Cadet 56 V / 60 Ah / 3.000 Wh
Drive:	Electric drive
Cutting height adjustment:	12 positions
Model no.:	33ABA7ES603

*When fully charged. Deviations are possible depending on lawn and weather conditions, and grass thickness.

FULL POWER UNTIL THE FINAL TOUCH

COMFORTABLE CUT & SEW SEAT WITH LEVER SEAT ADJUST

USB-PORT
Charge your electronic devices while driving, for example your smartphone.

VARIABLE SPEEDS WITH FOOT PEDAL CONTROL

107 CM MOWING DECK

SIDE DISCHARGE, COLLECT OR MULCH
The XT2 ES107 convinces with its standard side discharge mowing function, an integrated mulching kit and the optional grass catcher (as accessory, sold separately). Mulching and collecting may reduce the running time.

17 cm TURNING RADIUS

FRONT BUMPER

SERVICE- AND MAINTENANCE-FRIENDLY

ZERO EMISSIONS DURING YOUR WORK



NEW

THE ULTIMATE MOWING EXPERIENCE. NOW EVEN MORE ELECTRIFYING.

XZ5
ENDURO SERIES®



MOWING TIME
90 MIN*
4 HOURS CHARGING TIME

NEW



XZ5 EL107	
Cutting width:	107 cm
Area performance (rec.):	10.000 m ² /h
Collecting volume:	Optional 230 l
Engine:	Cub Cadet 56 V / 60 Ah / 3.000 Wh
Drive:	Electric drive
Cutting height adjustment:	15 positions
Model no.:	34BBA2CS603

*When fully charged. Deviations are possible depending on lawn and weather conditions, and grass thickness.



100 % ELECTRIC. 0 % COMPROMISE.

Think electric equipment compromises power? Think again. Our 60V MAX* battery system will provide you with the premium cut quality and performance you expect in yardcare.

LH5
FORCE SERIES



+ AVAILABLE IN BOTH 2,5 AH AND 5,0 AH OPTIONS

+ ZERO EMISSIONS DURING WORK

+ EASY AND RELIABLE PUSH TO START BUTTON – NO MORE PULLING CORDS

+ BRUSHLESS MOTOR DESIGNED TO MAXIMIZE EFFICIENCY AND EXTEND LIFE OF MACHINE

60 VOLT MAX*



EASY TO STORE

BOOSTED AIRFLOW TECHNOLOGY
For optimal transport of the cuttings to the grass catcher.

6-FOLD CUTTING HEIGHT ADJUSTMENT

VARIABLE DRIVE
Stepless speed control and rear-wheel drive make gardening easy.

ROBUST STEEL MOWER DECK

WHEELS WITH BALL BEARINGS

3-in-1

LM5 E 51 R	
Cutting width:	51 cm
Lawn area (rec.):	700 m ² /h
Collecting volume:	60 l
Engine:	Battery
Drive:	Rear wheel drive
Cutting height adjustment:	Central
Model no.:	18ASTR94603
Delivery without battery and charger	

POWER FOR YOUR GARDEN

60 VOLT MAX*



60V MAX* BATTERY – BP 6025	
Capacity / Energy:	2,5 Ah / 135 Wh
Charging time:	75 min
Weight:	1,2 kg
Model number:	49AP601-603



60V MAX* BATTERY – BP 6050	
Capacity / Energy:	5,0 Ah / 270 Wh
Charging time:	150 min
Weight:	1,9 kg
Model number:	49AP602-603



60V MAX* CHARGER – BC 6020	
Charging current:	2,0 A
Weight:	0,7 kg
Model number:	49AL601-603

Batteries and charger sold separately.

- Cruise control to set the speed
- Highly efficient brushless motor with long service life
- Axial fan delivery up to 180 km/h of power



60V MAX* LEAF BLOWER – LH5 B60

Speed (max.):	Up to 180 km/h
Air flow:	Up to 1.080 m³/h
Axial fan:	Standard
Weight without/with battery:	2,5 / 3,7 kg (with 2,5 Ah battery)
Model number:	41AT6BE-603

Delivery without battery and charger

- Tool-free chain change and chain tensioning
- Spirit level helps provide precise and level cutting
- High-efficiency brushless motor designed to optimize power, performance and longevity



60V MAX* CHAIN SAW – LH5 C60

Blade length:	40 cm
Chain speed:	13,5 m/s
Chain pitch:	3/8"
Weight without/with battery:	4,4 / 5,6 kg (with 2,5 Ah battery)
Model number:	41AT6CGR603

Delivery without battery and charger

60V MAX* TRIMMER – LH5 T60

Cutting width:	33 cm
Line thickness:	∅ 2,0 mm, double
Telescopic tube:	Standard
Weight without/with battery:	3,6 / 4,8 kg (with 2,5 Ah battery)
Model number:	41AT6TGT603

Delivery without battery and charger



- Two-stage speed control
- Line can be replaced with spool attached
- Lightweight design

60V MAX* HEDGE TRIMMER – LH5 H60

Cutting movements (max.):	1.500/min
Blade length:	60 cm
Blade spacing:	19 mm
Weight without/with battery:	3,4 / 4,6 kg (with 2,5 Ah battery)
Model number:	41AT6HK-603

Delivery without battery and charger



- Laser cut blade
- Oscillating saw at the end of the knife
- Full-bale handle designed to maximize maneuverability and minimize vibration

*Maximum initial battery voltage (measured without a workload) is 60 volts. Nominal voltage is 54 volts.



NEW

LR2 ES76

XT2 ES107



ENGINE		
Engine type	Cub Cadet 56 V / 30 Ah / 1.500 Wh	Cub Cadet 56 V / 60 Ah / 3.000 Wh
Engine rpm	2.083 min ⁻¹	2.100 min ⁻¹
DRIVE SYSTEM		
Transmission	Electric drive	Electric drive
Speeds	Variable	Variable
Control	Foot pedal control	Foot pedal control
Cruise control	Standard	Standard
CUTTING SYSTEM		
Lawn area (rec./up to)	3.000 m ² /h	8.000 m ² /h
Cutting width	76 cm	107 cm
Cutting height (min-max)	38–95 mm	25–100 mm
Cutting deck	–	stamped
Number of blades	1	2
Deck engagement	Electric PTO	Electric PTO
Deck height positions	5 positions	12 positions
Deck wheels	–	2 balls deck wheels
Wash nozzle/Mulch Kit/mulching blades	–/Optional /–	–/Standard/–
DISCHARGE SYSTEM		
Bag (capacity)/accessory no.	Optional 115 l/(19A30014OEM)	Optional 200 l/(19A30030100)
Bag fill indicator/grass deflector	–/Standard	–/Standard
FRAME		
Front axle	Steel	Heavy-duty cast-iron
Front bumper/rear bumper	Standard, blue / –	Standard, blue / –
Turning radius	46 cm	TIGHT TURN xTREME 17 cm
Wheel size (f/r in inch)	13 x 5 / 16 x 6,5	15 x 6 / 20 x 8
Wheel bearings	Sleeve bearings	Sleeve bearings
Frame	Easy entry frame	Robotically-welded
ELECTRIC		
Headlights	LED	LED
COMFORT		
Seat type	Cut & Sew, high back rest	Cut & Sew, high back rest
Seat adjustment	Tool-less	Lever, angled, 10 slide
Steering wheel	Standard	Ergonomic with gentle touch
Toolbox/Cupholder	–/Standard	Standard/Standard
USB Port	Standard	Standard
Mow-in-reverse	Standard	Standard
DIMENSIONS		
Noise level LpA/LwA/LwAg	80,1/93,8/95,0 dB (A)	79,8/93,6/94,0 dB (A)
Vibration value body / K-factor	1,0 / 0,5 m/s ²	1,0 / 0,5 m/s ²
Vibration value hand/arm / K-factor	5,0 / 1,5 m/s ²	5,0 / 1,5 m/s ²
Dimensions (L/W/H)	170 / 97 / 88 cm	180 / 115 / 120 cm
Net weight	122 kg	245 kg

Model number	33BA27JD603	33ABA7ES603
EAN		



XZ5 EL107

ENGINE	
Engine type	Cub Cadet 56 V / 60 Ah / 3.000 Wh
Engine rpm	2083 min ⁻¹
DRIVE SYSTEM	
Transmission	Electric drive
Speeds	Variable
Control	Foot pedal control
Cruise control	Standard
CUTTING SYSTEM	
Lawn area (rec./up to)	10.000 m ² /h
Cutting width	107 cm
Cutting height (min-max)	25–114 mm
Cutting deck	stamped
Number of blades	2
Deck engagement	Electric PTO
Deck height positions	15 positions
Deck wheels	2
Wash nozzle/Mulch Kit/mulching blades	–/Standard/–
DISCHARGE SYSTEM	
Bag (capacity)/accessory no.	Optional 230 l/(19A70054100)
Bag fill indicator/grass deflector	–/Standard
FRAME	
Front axle	–
Front bumper/rear bumper	Upper Tube Sub Frame
Turning radius	0 cm
Wheel size (f/r in inch)	11 x 6 / 20 x 8
Wheel bearings	–
Frame	Tubular steel frame
ELECTRIC	
Headlights	LED
COMFORT	
Seat type	Cut & Sew, high back rest
Seat adjustment	Lever
Steering wheel	2-way adjustable lap bars with comfort grips
Toolbox/Cupholder	Standard/Standard
USB Port	Dual
Mow-in-reverse	Standard
DIMENSIONS	
Noise level LpA/LwA/LwAg	n.a./n.a./n.a. dB (A)
Vibration value body / K-factor	1,0 / 0,5 m/s ²
Vibration value hand/arm / K-factor	5,0 / 1,5 m/s ²
Dimensions (L/W/H)	203 / 132 / 114 cm
Net weight	236 kg

Model number	34BBA2CS603
EAN	

	60V MAX* LEAF BLOWER LH5 B60	60V MAX* HEDGE TRIMMER LH5 H60	60V MAX* TRIMMER LH5 T60
FEATURES			
Speed (max.)	Up to 180 km/h	–	–
Air flow	Up to 1.080 m³/h	–	–
Speed stages	Stepless	–	–
Cutting movements (max.)	–	1.500/min	–
Blade length	–	60 cm	–
Cutting width	–	19 mm	33 cm
Chain speed	–	–	–
Line thickness	–	–	∅ 2,0 mm, double
Line spool	–	–	Easy winding without removing the reel
MAIN FEATURES			
Axial fan	Standard	–	–
Comfort handle	–	Standard	Standard
Dual action blades	–	Standard	–
DIMENSIONS			
Noise level LpA/LwA/LwAg	89/101/103 dB (A)	79,5/91,5/95 dB (A)	79,5/93/96 dB (A)
Vibration value hand/arm / K-factor	2,5 / 1,5 m/s²	3,0 / 1,5 m/s²	3,5 / 1,5 m/s²
Dimensions (L/W/H)	53 / 32 / 23 cm	106 / 26 / 24 cm	106 / 26 / 24 cm
Net weight	2,5 / 3,7 kg (with 2,5 Ah battery)	3,4 / 4,6 kg (with 2,5 Ah battery)	3,6 / 4,8 kg (with 2,5 Ah battery)
Model number			
	41AT6BE-603	41AT6HK-603	41AT6TG-603
EAN			
			

BATTERIES AND CHARGER [EACH SOLD SEPARATELY]

	60V MAX* BATTERY BP 6025	60V MAX* BATTERY BP 6050	60V MAX* CHARGER BC 6020
Capacity / Energy	2,5 Ah / 135 Wh	5,0 Ah / 270 Wh	2,0 A Charging current
Charging time	75 min	150 min	–
Voltage	54 V	54 V	–
Net weight	1,2 kg	1,9 kg	0,7 kg
Model number			
	49AP601-603	49AP602-603	49AL601-603
EAN			
			

	60V MAX* CHAIN SAW LH5 C60
FEATURES	
Speed (max.)	–
Air flow	–
Speed stages	–
Cutting movements (max.)	–
Blade length	40 cm
Cutting width	–
Chain speed	13,5 m/s
Line thickness	–
Line spool	–
MAIN FEATURES	
Axial fan	–
Comfort handle	–
Dual action blades	–
DIMENSIONS	
Noise level LpA/LwA/LwAg	91/102/104 dB (A)
Vibration value hand/arm / K-factor	3,5 / 1,5 m/s²
Dimensions (L/W/H)	93 / 29 / 27 cm
Net weight	4,4 / 5,6 kg (with 2,5 Ah battery)
Model number	
	41AT6CGR603
EAN	
	

	60V MAX* LAWNMOWER LM5 E 51 R
DRIVE SYSTEM	
Drive	Rear wheel drive
Driving stages	Variable
Speed (max.)	Variable
CUTTING SYSTEM	
Lawn area (rec./up to)	700 m²/h
Housing (material)	Steel
Cutting width	51 cm
Mowing options	3-in-1
Cutting height adjustment	Central
Cutting height (min/max)	38-88 mm
Bagging	Inclusive
Mulch Kit	Inclusive
Side discharge	–
Rear discharge without grass catcher	Standard
DISCHARGE SYSTEM	
Grass catcher	Soft bag
Grass catcher (capacity)	60 l
Filling level indicator	–
WHEELS	
Wheels (f/r)	150 mm / 200 mm
Wheel bearing	Double ball bearings
COMFORT	
Cutting deck washing nozzle	–
Bar	Ergo with softgrip
Folding bar	Standard
Height-adjustable bar	Standard, 3 steps
Soft-Grip	Standard
DIMENSIONS	
Noise level LpA/LwA/LwAg	78/92/98 dB (A)
Vibration value hand/arm / K-factor	2,5 / 1,5 m/s²
Dimensions (L/W/H)	160 / 56 / 110 cm
Net weight	31 kg
Model number	
	18ASTR94603
EAN	
	

LM1 FORCE SERIES



LC3 DP56



Cutting width:	56 cm
Cutting height:	60–110 mm
Line:	Ø 3,9 mm
Engine:	Cub Cadet 55 OHV
Wheels:	Ø 360 mm
Drive:	Pushed
Net weight:	31 kg
Model no.:	25C-262E603

STRONG ENOUGH TO CUT THROUGH GRASS AND BUSHES

The Cub Cadet LC3 DP56 mobile lawn trimmer is really strong and powerful. With its Cub Cadet engine and 56 cm cutting width, designed to cut long grass, weeds and low-growing bushes.

REPLACEMENT LINE FOR LC3 DP56



10 pcs. of cutting line AF3.20, cut to 3,9 mm x 47 cm length

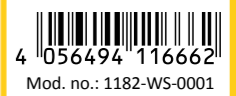

4 056494 116662
Mod. no.: 1182-WS-0001

LM SERIES – PRECISE CUT AND COMFORTABLE BAGGING

The Cub Cadet LM Series gives you the choice between bagging and discharging the clippings. A mulch kit is also available as an accessory, giving you the option of mulching your lawn. Many comfort features help get the job done efficiently and minimize fatigue.



LM1 AP46

Cutting width:	46 cm
Lawn area (rec.):	700 m ² /h
Collecting volume:	60 l
Engine:	Cub Cadet 35 OHV, Pull starter
Engine displacement:	79 cm ³
Drive:	Pushed
Cutting height adjustment:	6 positions/central
Model no.:	11C-TQMG603



LM1 AR46

Cutting width:	46 cm
Lawn area (rec.):	700 m ² /h
Collecting volume:	60 l
Engine:	Cub Cadet 35 OHV, Pull starter
Engine displacement:	79 cm ³
Drive:	Rear-wheel drive
Cutting height adjustment:	6 positions/central
Model no.:	12C-TQMG603



LM1 CR53

Cutting width:	53 cm
Lawn area (rec.):	950 m ² /h
Collecting volume:	70 l
Engine:	Cub Cadet 45 OHV, Pull starter
Engine displacement:	140 cm ³
Drive:	Rear-wheel drive
Cutting height adjustment:	6 positions/central
Model no.:	12D-PQSC603



LM1 DP53

Cutting width:	53 cm
Lawn area (rec.):	950 m ² /h
Collecting volume:	70 l
Engine:	Cub Cadet 55 OHV, Pull starter
Engine displacement:	159 cm ³
Drive:	Pushed
Cutting height adjustment:	6 positions/central
Model no.:	11E-PTKC603

LM2 FORCE SERIES

LM3 FORCE SERIES

SELF-PROPELLED
MySpeed™ models can adapt to your personal pace (LM2 and LM3 series).

HARD TOP BAG WITH FILL INDICATOR
(LM3 series)

ERGONOMIC HANDLEBAR
Height-adjustable, foldable handle, easy to store.

CENTRAL CUTTING HEIGHT ADJUSTMENT
Comfortably change the cutting height centrally with one lever – choose from 6 different positions.

STRONG AND DURABLE STEEL DECK

LARGE GRASS CATCHER
Helps reduce the number of dump runs and save you time.

HIGH REAR WHEELS
(LM3 series)

BALL BEARINGS

POWERFUL CUB CADET- AND BRIGGS & STRATTON®-ENGINES



3-in-1

POWERED BY
Cub Cadet

MYSPEED

LM2 DR46s

Cutting width:	46 cm
Lawn area (rec.):	750 m ² /h
Collecting volume:	60 l
Engine:	Cub Cadet 55 OHV, Pull starter/AutoChoke
Engine displacement:	159 cm ³
Drive:	Rear-wheel drive
Cutting height adjustment:	6 positions/central
Model no.:	12EBTQKC603



3-in-1

POWERED BY
Cub Cadet

MYSPEED

LM2 DR46es

Cutting width:	46 cm
Lawn area (rec.):	750 m ² /h
Collecting volume:	60 l
Engine:	Cub Cadet 55 OHV, Electric
Engine displacement:	159 cm ³
Drive:	Rear-wheel drive
Cutting height adjustment:	6 positions/central
Model no.:	12ECTQS7603



3-in-1

POWERED BY
Cub Cadet

MYSPEED

LM2 DR53s

Cutting width:	53 cm
Lawn area (rec.):	950 m ² /h
Collecting volume:	70 l
Engine:	Cub Cadet 55 OHV, Pull starter/AutoChoke
Engine displacement:	159 cm ³
Drive:	Rear-wheel drive
Cutting height adjustment:	6 positions/central
Model no.:	12EBPQKC603



4-in-1

POWERED BY
Cub Cadet

MYSPEED

LM3 CRC46s

Cutting width:	46 cm
Lawn area (rec.):	750 m ² /h
Collecting volume:	60 l
Engine:	Cub Cadet 45 OHV, Pull starter
Engine displacement:	140 cm ³
Drive:	Rear-wheel drive
Cutting height adjustment:	6 positions/central
Model no.:	12DBTVSC603



4-in-1

POWERED BY
Cub Cadet

MYSPEED

LM3 CR53s

Cutting width:	53 cm
Lawn area (rec.):	950 m ² /h
Collecting volume:	70 l
Engine:	B&S 750 EX DOV Series, Pull starter
Engine displacement:	161 cm ³
Drive:	Rear-wheel drive
Cutting height adjustment:	6 positions/central
Model no.:	12ABPV9B603



4-in-1

POWERED BY
Cub Cadet

MYSPEED

LM3 DR53es

Cutting width:	53 cm
Lawn area (rec.):	950 m ² /h
Collecting volume:	70 l
Engine:	Cub Cadet 55 OHV ES, Electric
Engine displacement:	159 cm ³
Drive:	Rear-wheel drive
Cutting height adjustment:	6 positions/central
Model no.:	12ECPV57603

	LC3 DP56	LM1 AP46	LM1 AR46
ENGINE			
Engine type	Cub Cadet 55 OHV	Cub Cadet 35 OHV	Cub Cadet 35 OHV
Engine displacement	159 cm ³	79 cm ³	79 cm ³
Rated power	2,1 kW / 2.800 min ⁻¹	1,5 kW / 2.800 min ⁻¹	1,5 kW / 2.800 min ⁻¹
Engine start	Pull starter	Pull starter	Pull starter
Tank volume (capacity)	1,0 l	0,75 l	0,75 l
DRIVE SYSTEM			
Drive	Pushed	Pushed	Rear-wheel drive
Selectable speeds	–	–	1
Speed (max)	–	–	3,6 km/h
CUTTING SYSTEM			
Lawn area (rec./up to)	1.000 m ² /h	700 m ² /h	700 m ² /h
Cutting deck (material)	–	Steel	Steel
Cutting width	56 cm	46 cm	46 cm
Cutting options	–	3-in-1 Option	3-in-1 Option
Cutting height adjustment	–	6 positions/central	6 positions/central
Cutting height (min–max)	60–110 mm	28–92 mm	28–92 mm
Bagging	–	Standard	Standard
Mulch Kit	–	Optional (196-588-678)	Optional (196-588-678)
Side discharge	–	–	–
Rear discharge without collector	–	Standard	Standard
BAGGING			
Gras catcher type	–	Soft bag	Soft bag
Collecting volume	–	60 l	60 l
Bag fill indicator	–	–	–
WHEELS			
Wheels (F/R)	∅ 360 mm	180 mm / 200 mm	180 mm / 200 mm
Wheel bearing	Slide bearings	double ball bearings	double ball bearings
COMFORT			
Washing nozzle	–	Standard	Standard
Handlebar type	3 positions	Ergonomic	Ergonomic
Foldable handlebar	–	Standard	Standard
Height adjustable handlebar	–	Standard	Standard
Soft-Grip	–	Standard	Standard
DIMENSIONS			
Noise level LpA/LwA/LwAg	93/106/108 dB (A)	84/94/96 dB (A)	84/94/96 dB (A)
Vibration value hand/arm / K-factor	6,5 / 1,5 m/s ²	5,0 / 1,5 m/s ²	5,0 / 1,5 m/s ²
Dimensions (L/W/H)	140 / 55 / 100 cm	155 / 49 / 114 cm	155 / 49 / 114 cm
Net weight	31 kg	28 kg	31 kg
Model number	25C-262E603	11C-TQMG603	12C-TQMG603
EAN	 4 008423 881967	 4 008423 892390	 4 008423 922646

	LM1 CR53	LM1 DP53
ENGINE		
Engine type	Cub Cadet 45 OHV	Cub Cadet 55 OHV
Engine displacement	140 cm ³	159 cm ³
Rated power	2,1 kW / 2.800 min ⁻¹	2,5 kW / 2800 min ⁻¹
Engine start	Pull starter	Pull starter
Tank volume (capacity)	1,0 l	1,0 l
DRIVE SYSTEM		
Drive	Rear-wheel drive	Pushed
Selectable speeds	1	–
Speed (max)	3,6 km/h	– km/h
CUTTING SYSTEM		
Lawn area (rec./up to)	950 m ² /h	950 m ² /h
Cutting deck (material)	Steel	Steel
Cutting width	53 cm	53 cm
Cutting options	3-in-1 Option	4-in-1
Cutting height adjustment	6 positions/central	6 positions/central
Cutting height (min–max)	28–92 mm	28–92 mm
Bagging	Standard	Standard
Mulch Kit	Optional (196-589-678)	Standard
Side discharge	–	Standard
Rear discharge without collector	Standard	Standard
BAGGING		
Gras catcher type	Soft bag	Soft bag
Collecting volume	70 l	70 l
Bag fill indicator	–	–
WHEELS		
Wheels (F/R)	200 mm / 200 mm	200 mm / 280 mm
Wheel bearing	double ball bearings	double ball bearings
COMFORT		
Washing nozzle	Standard	Standard
Handlebar type	Ergonomic	Ergonomic
Foldable handlebar	Standard	Standard
Height adjustable handlebar	Standard	Standard
Soft-Grip	Standard	Standard
DIMENSIONS		
Noise level LpA/LwA/LwAg	86/96/98 dB (A)	86/96/98 dB (A)
Vibration value hand/arm / K-factor	5,0 / 1,5 m/s ²	5,0 / 1,5 m/s ²
Dimensions (L/W/H)	162 / 58 / 114 cm	– cm / – cm / – cm
Net weight	34 kg	39 kg
Model number	12D-PQSC603	11E-PTKC603
EAN	 4 008423 872637	 4 008423 877007

	LM2 DR46s	LM2 DR46es	LM2 DR53s
ENGINE			
Engine type	Cub Cadet 55 OHV	Cub Cadet 55 OHV	Cub Cadet 55 OHV
Engine displacement	159 cm ³	159 cm ³	159 cm ³
Rated power	2,5 kW / 2.800 min ⁻¹	2,5 kW / 2.800 min ⁻¹	2,5 kW / 2.600 min ⁻¹
Engine start	Pull starter/AutoChoke	Electric	Pull starter/AutoChoke
Tank volume (capacity)	1,0 l	1,0 l	1,0 l
DRIVE SYSTEM			
Drive	Rear-wheel drive	Rear-wheel drive	Rear-wheel drive
Selectable speeds	Variable	Variable	Variable
Speed (max)	0–3,6 km/h	0–3,6 km/h	0–3,6
CUTTING SYSTEM			
Lawn area (rec./up to)	750 m ² /h	750 m ² /h	950 m ² /h
Cutting deck (material)	Steel	Steel	Steel
Cutting width	46 cm	46 cm	53 cm
Cutting options	3-in-1	3-in-1	3-in-1
Cutting height adjustment	6 positions/central	6 positions/central	6 positions/central
Cutting height (min–max)	28–92 mm	28–92 mm	28–92 mm
Bagging	Standard	Standard	Standard
Mulch Kit	Standard	Standard	Standard
Side discharge	–	–	–
Rear discharge without collector	Standard	Standard	Standard
BAGGING			
Gras catcher type	Soft bag	Soft bag	Soft bag
Collecting volume	60 l	60 l	70 l
Bag fill indicator	–	–	–
WHEELS			
Wheels (F/R)	180 mm / 200 mm	180 mm / 200 mm	200 mm / 280 mm
Wheel bearing	double ball bearings	double ball bearings	double ball bearings
COMFORT			
Washing nozzle	Standard	Standard	Standard
Handlebar type	MySpeed™	MySpeed™	MySpeed™
Foldable handlebar	Standard	Standard	Standard
Height adjustable handlebar	Standard	Standard	Standard
Soft-Grip	–	–	–
DIMENSIONS			
Noise level LpA/LwA/LwAg	84/94/96 dB (A)	84/94/96 dB (A)	86/96/98 dB (A)
Vibration value hand/arm / K-factor	5,0 / 1,5 m/s ²	5,0 / 1,5 m/s ²	5,0 / 1,5 m/s ²
Dimensions (L/W/H)	150 / 49 / 114 cm	150 / 49 / 114 cm	162 / 58 / 114 cm
Net weight	31 kg	35 kg	34 kg
Model number	12EBTQKC603	12ECTQS7603	12EBPQKC603
EAN	 4 008423 866148	 4 008423 866247	 4 008423 866131

	LM3 CRC46s	LM3 CR53s	LM3 DR53es
ENGINE			
Engine type	Cub Cadet 45 OHV	B&S 750 EX DOV Series	Cub Cadet 55 OHV ES
Engine displacement	140 cm ³	161 cm ³	159 cm ³
Rated power	2,1 kW / 2.800 min ⁻¹	n.v. kW / n.v. min ⁻¹	2,5 kW / 2.600 min ⁻¹
Engine start	Pull starter	Pull starter	Electric
Tank volume (capacity)	1,0 l	1,0 l	1,0 l
DRIVE SYSTEM			
Drive	Rear-wheel drive	Rear-wheel drive	Rear-wheel drive
Selectable speeds	Variable	Variable	Variable
Speed (max)	0–3,6 km/h	0–3,6 km/h	0–3,6 km/h
CUTTING SYSTEM			
Lawn area (rec./up to)	750 m ² /h	950 m ² /h	950 m ² /h
Cutting deck (material)	Steel	Steel	Steel
Cutting width	46 cm	53 cm	53 cm
Cutting options	4-in-1	4-in-1	4-in-1
Cutting height adjustment	6 positions/central	6 positions/central	6 positions/central
Cutting height (min–max)	28–92 mm	28–92 mm	28–92 mm
Bagging	Standard	Standard	Standard
Mulch Kit	Standard	Standard	Standard
Side discharge	Standard	Standard	Standard
Rear discharge without collector	Standard	Standard	Standard
BAGGING			
Gras catcher type	Soft bag with hard top	Soft bag with hard top	Soft bag with hard top
Collecting volume	60 l	70 l	70 l
Bag fill indicator	Standard	Standard	Standard
WHEELS			
Wheels (F/R)	180 mm / 280 mm	200 mm / 280 mm	200 mm / 280 mm
Wheel bearing	double ball bearings	double ball bearings	double ball bearings
COMFORT			
Washing nozzle	Standard	Standard	Standard
Handlebar type	MySpeed™	MySpeed™	MySpeed™
Foldable handlebar	Standard	Standard	Standard
Height adjustable handlebar	Standard	Standard	Standard
Soft-Grip	–	–	–
DIMENSIONS			
Noise level LpA/LwA/LwAg	84/94/96 dB (A)	n.a./n.a./n.a. dB (A)	86/96/98 dB (A)
Vibration value hand/arm / K-factor	5,0 / 1,5 m/s ²	n.a. / n.a. m/s ²	5,0 / 1,5 m/s ²
Dimensions (L/W/H)	155 / 49 / 114 cm	162 / 58 / 114 cm	162 / 58 / 114 cm
Net weight	34 kg	36 kg	41 kg
Model number	12DBTVSC603	12ABPV9B603	12ECPV57603
EAN	 4 008423 877045	 4 008423 922998	 4 008423 866155

LR1 FORCE SERIES



COMPACT AND VERSATILE LIKE NEVER BEFORE

Modern design, versatility and comfortable mowing – just three of the many reasons to go for the Cub Cadet MINI-RIDER. The compact and manoeuvrable Cub Cadet MINI-RIDER models with electric start are equipped with powerful and low-maintenance Cub Cadet engines. If you want to collect, discharge or mulch your grass clippings, this is your go-to mower. Thanks to their space saving design, these Cub Cadet MINI-RIDER models are compact and help save garage space.

MOW-IN-REVERSE

The Reverse Mowing Technology allows you to continue mowing while backing up your MINI-RIDER. As a safety precaution this function must be activated manually. Always make sure that no children or animals are near the mowing area!

200 LITRE GRASS CATCHER
(Models LR1 MR76 and LR2 NR76)

INTELLIGENT PARKING ASSISTANCE (ONLY LR2)
the IPA system helps park your MINI-RIDER in the garage with ease. The intelligent system is designed to reduce the speed of your MINI-RIDER while in reverse.

4,9 LITRE FUEL TANK

LED LIGHTS
(LR2-series)

LARGE TYRES
Lawn-friendly, yet handy, even on uneven terrain.

TRANSMATIC (LR1) OR HYDROSTAT (LR2) TRANSMISSION

CUTTING HEIGHT ADJUSTMENT & PTO CLUTCH
Easily adjustable cutting height over 5 positions, from 38 to 95 mm. Both levers are located ergonomically on the right side of the seat.

FRONT BUMPER

76 CM MOWING DECK



3-in-1
OPTION

POWERED BY
Cub Cadet



LR1 MR76

Cutting width:	76 cm
Lawn area (rec.):	2.500 m ² /h
Collecting volume:	Standard 200 l
Engine:	Cub Cadet OHV
Engine displacement:	382 cm ³
Drive:	Transmatic
Cutting height adjustment:	5 positions
Model no.:	13B726HD603

2-in-1
OPTION

POWERED BY
Cub Cadet



LR1 MS76

Cutting width:	76 cm
Lawn area (rec.):	3.000 m ² /h
Collecting volume:	Optional 115 l
Engine:	Cub Cadet OHV
Engine displacement:	382 cm ³
Drive:	Transmatic
Cutting height adjustment:	5 positions
Model no.:	13B726JD603

3-in-1
OPTION

POWERED BY
Cub Cadet



LR2 NR76

Cutting width:	76 cm
Lawn area (rec.):	2.500 m ² /h
Collecting volume:	Standard 200 l
Engine:	Cub Cadet OHV
Engine displacement:	439 cm ³
Drive:	Hydrostatic
Cutting height adjustment:	5 positions
Model no.:	13AB21HD603

2-in-1
OPTION

POWERED BY
Cub Cadet



LR2 NS76

Cutting width:	76 cm
Lawn area (rec.):	3.000 m ² /h
Collecting volume:	Optional 115 l
Engine:	Cub Cadet OHV
Engine displacement:	439 cm ³
Drive:	Hydrostatic
Cutting height adjustment:	5 positions
Model no.:	13AB21JD603



Learn more

LR1 MR76

LR1 MS76

ENGINE		
Engine type	Cub Cadet OHV	Cub Cadet OHV
Engine displacement	382 cm ³	382 cm ³
Rated power	7,4 kW / 2.700 min ⁻¹	7,9 kW / 2.900 min ⁻¹
Cylinders	Single	Single
Tank volume (capacity)	4,9 l	4,9 l
Lubrication	Fully pressurized automotive-style oil pump with spin-on oil filter	Fully pressurized automotive-style oil pump with spin-on oil filter
DRIVE SYSTEM		
Transmission	Transmatic	Transmatic
Speeds	6 (f/r), shift-on-the-go	6 (f/r), shift-on-the-go
Control	Foot pedal control with lever for manual pre-selection	Foot pedal control with lever for manual pre-selection
CUTTING SYSTEM		
Lawn area (rec./up to)	2.500 m ² /h	3.000 m ² /h
Cutting width	76 cm	76 cm
Cutting height (min-max)	38-95 mm	38-95 mm
Cutting options	3-in-1 option	2-in-1-option
Number of blades	1	1
Deck engagement	Manual lever control	Manual lever control
Deck height positions	5 positions	5 positions
Wash nozzle/Mulch Kit	Standard/Optional	Standard/Optional
DISCHARGE SYSTEM		
Bag (capacity)/accessory no.	Standard 200 l/-	Optional 115 l/(19A30014OEM)
Bag lever/Hardtop	2 grips/Hardtop	-/-
Bag fill indicator/grass deflector	Standard/Optional	-/Standard
FRAME		
Front axle	Steel	Steel
Front bumper	Standard	Standard
Turning radius	46 cm	46 cm
Wheel size (f/r in inch)	13 x 5 / 16 x 6,5	13 x 5 / 16 x 6,5
Wheel bearings	Sleeve bearings	Sleeve bearings
Frame	Easy entry frame	Easy entry frame
ELECTRIC		
Battery	12V, 135CCA, AGM	12V, 135CCA, AGM
Headlights	-	-
COMFORT		
Seat type	Comfort Seat	Comfort Seat
Seat adjustment	Tool-less	Tool-less
Steering wheel	Standard	Standard
Mow-in-reverse	Standard	Standard
Battery charger	(196-967-678)	(196-967-678)
DIMENSIONS		
Noise level LpA/LwA/LwAg	88/98/100 dB (A)	88/98/100 dB (A)
Vibration value body/K-factor	1,0 / 0,5 m/s ²	1,0 / 0,5 m/s ²
Vibration value hand/arm / K-factor	5,0 / 1,5 m/s ²	5,0 / 1,5 m/s ²
Dimensions (L/W/H)	225 / 86 / 112 cm	157 / 85 / 112 cm
Net weight	144 kg	126 kg
Model number	13B726HD603	13B726JD603
EAN	 4 008423 892284	 4 008423 892154

LR2 NR76

LR2 NS76

ENGINE		
Engine type	Cub Cadet OHV	Cub Cadet OHV
Engine displacement	439 cm ³	439 cm ³
Rated power	8,1 kW / 2.700 min ⁻¹	8,6 kW / 2.950 min ⁻¹
Cylinders	Single	Single
Tank volume (capacity)	4,9 l	4,9 l
Lubrication	Fully pressurized automotive-style oil pump with spin-on oil filter	Fully pressurized automotive-style oil pump with spin-on oil filter
DRIVE SYSTEM		
Transmission	Hydrostatic	Hydrostatic
Speeds	Stepless	Stepless
Control	Foot pedal control	Foot pedal control
CUTTING SYSTEM		
Lawn area (rec./up to)	2.500 m ² /h	3.000 m ² /h
Cutting width	76 cm	76 cm
Cutting height (min-max)	38-95 mm	38-95 mm
Cutting options	3-in-1 option	2-in-1 option
Number of blades	1	1
Deck engagement	Manual lever control	Manual lever control
Deck height positions	5 positions	5 positions
Wash nozzle/Mulch Kit	Standard/Optional	Standard/Optional
DISCHARGE SYSTEM		
Bag (capacity)/accessory no.	Standard 200 l/-	Optional 115 l/(19A30014OEM)
Bag lever/Hardtop	2 grips/Hardtop	-/-
Bag fill indicator/grass deflector	Standard/Optional	-/Standard
FRAME		
Front axle	Steel	Steel
Front bumper	Standard	Standard
Turning radius	46 cm	46 cm
Wheel size (f/r in inch)	13 x 5 / 16 x 6,5	13 x 5 / 16 x 6,5
Wheel bearings	Sleeve bearings	Sleeve bearings
Frame	Easy entry frame	Easy entry frame
ELECTRIC		
Battery	12V, 135CCA, AGM	12V, 135CCA, AGM
Headlights	LED	LED
COMFORT		
Seat type	High Back Comfort Seat	High Back Comfort Seat
Seat adjustment	Tool-less	Tool-less
Steering wheel	Standard	Standard
Mow-in-reverse	Standard	Standard
Battery charger	(196-967-678)	(196-967-678)
DIMENSIONS		
Noise level LpA/LwA/LwAg	88/98/100 dB (A)	88/98/100 dB (A)
Vibration value body/K-factor	1,0 / 0,5 m/s ²	1,0 / 0,5 m/s ²
Vibration value hand/arm / K-factor	5,0 / 1,5 m/s ²	5,0 / 1,5 m/s ²
Dimensions (L/W/H)	225 / 86 / 112 cm	157 / 85 / 112 cm
Net weight	172 kg	127 kg
Model number	13AB21HD603	13AB21JD603
EAN	 4 008423 916041	 4 008423 916058



LT FORCE SERIES

ENJOYABLE EXPERIENCE

Cub Cadet LT Series lawn tractors are extraordinarily versatile. They excel when it comes to covering large areas quickly thanks to the oversized grass catcher – and even more with side discharge, eliminating the need to stop and empty the catcher. Thanks to the user-friendly cutting height adjustment, the LT Series helps to achieve optimum cutting results – even on difficult ground.



CENTRAL REAR DISCHARGE
All our rear discharge tractors are designed to transport grass clippings into the grass catcher with optimal efficiency. All LT Series rear discharge models feature a grass catcher made of durable fabric for flexibility and have an air passage to help air flow and collection.

**SOFT GRIP
STEERING WHEEL**

MOW-IN-REVERSE
Reverse mowing technology. Allows you to cut while in reverse (LT2 and LT3 series).

**COMFORTABLE SEAT
WITH HIGH BACKREST**

PIVOTING ONE-PIECE HOOD
The entire engine hood can be folded up within seconds without tools, for easy maintenance.

**CUTTING HEIGHT
ADJUSTMENT**
5-position height adjustment to easily change the cutting height (30–95 mm).

**TRANSMATIC, HYDROSTATIC
OR AUTODRIVE DRIVE SYSTEM**

STEEL FRAME



POWERED BY
Cub Cadet

Placeholder

LT1 NR92

Cutting width:	92 cm
Area performance (rec.):	3.500 m ² /h
Collecting volume:	240 l
Engine:	Cub Cadet OHV
Engine displacement:	439 cm ³
Drive:	Transmatic
Cutting height adjustment:	5 positions
Model no.:	13AB77BE603



POWERED BY
Cub Cadet

LT1 NS92

Cutting width:	92 cm
Area performance (rec.):	4.000 m ² /h
Collecting volume:	Optional 200 l
Engine:	Cub Cadet OHV
Engine displacement:	439 cm ³
Drive:	Transmatic
Cutting height adjustment:	5 positions
Model no.:	13AB77BY603



POWERED BY
Cub Cadet

LT2 NR92

Cutting width:	92 cm
Lawn area (rec.):	3.500 m ² /h
Collecting volume:	240 l
Engine:	Cub Cadet OHV
Engine displacement:	439 cm ³
Drive:	Hydrostatic
Cutting height adjustment:	5 positions
Model no.:	13AB71BE603



POWERED BY
Cub Cadet

LT2 NS92

Cutting width:	92 cm
Lawn area (rec.):	4.000 m ² /h
Collecting volume:	Optional 200 l
Engine:	Cub Cadet OHV
Engine displacement:	439 cm ³
Drive:	Autodrive
Cutting height adjustment:	5 positions
Model no.:	13AB78BY603



POWERED BY
Cub Cadet

LT3 PR105

Cutting width:	105 cm
Lawn area (rec.):	4.500 m ² /h
Collecting volume:	240 l
Engine:	Cub Cadet OHV, V-TWIN dual cylinder
Engine displacement:	679 cm ³
Drive:	Hydrostatic
Cutting height adjustment:	5 positions
Model no.:	13AJ71BN603



POWERED BY
Cub Cadet

LT3 PS107

Cutting width:	107 cm
Lawn area (rec.):	5.500 m ² /h
Collecting volume:	Optional 200 l
Engine:	Cub Cadet OHV, V-TWIN dual cylinder
Engine displacement:	679 cm ³
Drive:	Autodrive
Cutting height adjustment:	5 positions
Model no.:	13AJ78BS603

	LT1 NR92	LT1 NS92	LT2 NR92
ENGINE			
Engine type	Cub Cadet OHV	Cub Cadet OHV	Cub Cadet OHV
Engine displacement	439 cm ³	439 cm ³	439 cm ³
Rated power	8,1 kW / 2.700 min ⁻¹	8,3 kW / 2.800 min ⁻¹	8,1 kW / 2.700 min ⁻¹
Cylinders	Single	Single	Single
Tank volume (capacity)	3,8 l	3,8 l	3,8 l
DRIVE SYSTEM			
Transmission	Transmatic	Transmatic	Hydrostatic
Speeds	7 (f/r), shift-on-the-go	7 (f/r), shift-on-the-go	Variabel (f/r)
Control	Foot pedal control with lever for manual pre-selection	Foot pedal control with lever for manual pre-selection	Foot pedal control
Cruise control	-	-	-
CUTTING SYSTEM			
Lawn area (rec./up to)	3.500 m ² /h	4.000 m ² /h	3.500 m ² /h
Cutting width	92 cm	92 cm	92 cm
Cutting height (min-max)	30-95 mm	30-95 mm	30-95 mm
Number of blades	2	2	2
Deck engagement	Manual lever control	Manual lever control	Manual lever control
Deck height positions	5 positions	5 positions	5 positions
Deck wheels	-	-	-
Wash nozzle/Mulch Kit	-/optional (196-749A678)	-/spring-loaded	-/optional (196-749A678)
DISCHARGE SYSTEM			
Type	Rear Discharge	Side Discharge	Rear Discharge
Bag (capacity)/accessory no.	240 l/-	Optional 200 l/(OEM-190-180A)	240 l/-
Bag lever/hardtop	Telescopic handle/PVC hardtop	-/-	Telescopic handle/PVC hardtop
Bag fill indicator/grass deflector	-/(196-750A678)	-/Standard	-/optional (196-750A678)
FRAME			
Front axle	Steel	Steel	Steel
Front bumper	optional (OEM-190-679)	optional (OEM-190-679)	optional (OEM-190-679)
Turning radius	46 cm	46 cm	46 cm
Wheel size (f/r in inch)	15 x 6 / 18 x 9,5	15 x 6 / 20 x 8	15 x 6 / 18 x 9,5
Wheel bearings	Sleeve bearings	Sleeve bearings	Sleeve bearings
Frame	Easy entry frame	Easy entry frame	Easy entry frame
Headlights	Standard	Standard	Standard
COMFORT			
Seat type	High Back Comfort Seat	High Back Comfort Seat	High Back Comfort Seat
Seat adjustment	Tool-less	Tool-less	Tool-less
Steering wheel	Standard	Standard	Soft-Grip
Toolbox/Cupholder	-/-	-/-	-/-
Mow-in-reverse	-	-	Standard
Battery charger	optional (196-967-678)	optional (196-967-678)	optional (196-967-678)
DIMENSIONS			
Noise level LpA/LwA/LwAg	88/98/100 dB (A)	88/98/100 dB (A)	88/98/100 dB (A)
Vibration value body/K-factor	1,0 / 0,5 m/s ²	1,0 / 0,5 m/s ²	1,0 / 0,5 m/s ²
Vibration value hand/arm / K-factor	5,0 / 1,5 m/s ²	5,0 / 1,5 m/s ²	5,0 / 1,5 m/s ²
Dimensions (L/W/H)	225 / 99 / 103 cm	170 / 107 / 100 cm	225 / 99 / 103 cm
Net weight	195 kg	150 kg	195 kg
Model number	13AB77BE603	13AB77BY603	13AB71BE603
EAN			

	LT2 NS92	LT3 PR105	LT3 PS107
ENGINE			
Engine type	Cub Cadet OHV	Cub Cadet OHV	Cub Cadet OHV
Engine displacement	439 cm ³	679 cm ³	679 cm ³
Rated power	8,3 kW / 2.800 min ⁻¹	12,7 kW / 2.700 min ⁻¹	12,3 kW / 2.600 min ⁻¹
Cylinders	Single	V-TWIN dual cylinder	V-TWIN dual cylinder
Tank volume (capacity)	3,8 l	3,8 l	3,8 l
DRIVE SYSTEM			
Transmission	Autodrive	Hydrostatic	Autodrive
Speeds	Variabel (f/r)	Variabel (f/r)	Variabel (f/r)
Control	Manual lever control	Foot pedal control	Manual lever control
Cruise control	-	-	-
CUTTING SYSTEM			
Lawn area (rec./up to)	4.000 m ² /h	4.500 m ² /h	5.500 m ² /h
Cutting width	92 cm	105 cm	107 cm
Cutting height (min-max)	30-95 mm	30-95 mm	30-95 mm
Number of blades	2	2	2
Deck engagement	Manual lever control	Manual lever control	Manual lever control
Deck height positions	5 positions	5 positions	5 positions
Deck wheels	-	2	2
Wash nozzle/Mulch Kit	-/spring-loaded	Standard/optional (196-749A678)	Standard/Standard
DISCHARGE SYSTEM			
Type	Side Discharge	Rear Discharge	Side Discharge
Bag (capacity)/accessory no.	Optional 200 l/optional (OEM-190-180A)	240 l/-	Optional 200 l/optional (OEM-190-180A)
Bag lever/hardtop	-/-	Telescopic handle/PVC hardtop	-/-
Bag fill indicator/grass deflector	-/Standard	-/optional (196-750A678)	-/Standard
FRAME			
Front axle	steel	Heavy-duty cast-iron	Heavy-duty cast-iron
Front bumper	optional (OEM-190-679)	Standard	Standard
Turning radius	46 cm	46 cm	46 cm
Wheel size (f/r in inch)	15 x 6 / 20 x 8	15 x 6 / 18 x 9,5	15 x 6 / 20 x 8
Wheel bearings	Sleeve bearings	Sleeve bearings	Sleeve bearings
Frame	Easy entry frame	Easy entry frame	Easy entry frame
Headlights	Standard	Standard	Standard
COMFORT			
Seat type	High Back Comfort Seat	High Back Comfort Seat	High Back Comfort Seat
Seat adjustment	Tool-less	Tool-less	Tool-less
Steering wheel	Soft-Grip	Soft-Grip	Soft-Grip
Toolbox/Cupholder	-/-	-/-	-/-
Mow-in-reverse	Standard	Standard	Standard
Battery charger	optional (196-967-678)	optional (196-967-678)	optional (196-967-678)
DIMENSIONS			
Noise level LpA/LwA/LwAg	88/98/100 dB (A)	88/98/100 dB (A)	88/98/100 dB (A)
Vibration value body/K-factor	1,0 / 0,5 m/s ²	1,0 / 0,5 m/s ²	1,0 / 0,5 m/s ²
Vibration value hand/arm / K-factor	5,0 / 1,5 m/s ²	5,0 / 1,5 m/s ²	5,0 / 1,5 m/s ²
Dimensions (L/W/H)	170 / 107 / 100 cm	225 / 110 / 103 cm	170 / 115 / 100 cm
Net weight	150 kg	198 kg	175 kg
Model number	13AB78BY603	13AJ71BN603	13AJ78BS603
EAN			

XT1® ENDURO SERIES®

Cub Cadet® ENGINES

Select XT lawn tractors are equipped with a powerful Cub Cadet engine – developed in the USA with global parts.



Learn more

POWER AND EFFICIENCY COMBINED

The Cub Cadet XT series sets standards for power, performance and robust quality. XT1 lawn tractors are ideally equipped for mowing, collecting and transporting clippings and can also be expanded with a special range of accessories.



DIAGONAL ADJUSTABLE SEAT
Individually adaptable.



PUSH BUTTON BLADE START



MECHANICALLY SUPPORTED CUTTING HEIGHT ADJUSTMENT



HYDROSTATIC POWER TRANSMISSION
Stable, smooth starting for precise mowing.



XT1 OS96

Cutting width:	96 cm
Lawn area (rec.):	6.000 m ² /h
Collecting volume:	Optional 200 l
Engine:	Cub Cadet
Engine displacement:	547 cm ³
Drive:	Hydrostatic
Cutting height adjustment:	12 positions
Model no.:	13A8A1TF603



XT1 OS107

Cutting width:	107 cm
Lawn area (rec.):	8.000 m ² /h
Collecting volume:	Optional 200 l
Engine:	Cub Cadet
Engine displacement:	547 cm ³
Drive:	Hydrostatic
Cutting height adjustment:	12 positions
Model no.:	13A8A1TS603



XT1 OR95

Cutting width:	95 cm
Lawn area (rec.):	5.500 m ² /h
Collecting volume:	320 l
Engine:	Cub Cadet
Engine displacement:	547 cm ³
Drive:	Hydrostatic
Cutting height adjustment:	12 positions
Model no.:	13A8A1TB603



XT1 OR106

Cutting width:	106 cm
Lawn area (rec.):	7.500 m ² /h
Collecting volume:	320 l
Engine:	Cub Cadet
Engine displacement:	547 cm ³
Drive:	Hydrostatic
Cutting height adjustment:	12 positions
Model no.:	13A8A1TR603

Cub Cadet TIGHT TURN XTREME

Just 17 cm turning radius thanks to TIGHT TURN XTREME.



Learn more

POWER FOR GREATER CHALLENGES

The Cub Cadet XT2 offers you a high level of power, control functions and durability. XT2 lawn tractors are ideal for working on tough terrain, transporting and using additional accessories, whatever the season.

Powered by
Kawasaki



XT2 PR95

Cutting width:	95 cm
Lawn area (rec.):	6.000 m ² /h
Collecting volume:	320 l
Engine:	Kawasaki, V-TWIN dual cylinder
Engine displacement:	603 cm ³
Drive:	Hydrostatic
Cutting height adjustment:	12 positions
Model no.:	13AGA1TB603

POWERED BY
Cub Cadet



XT2 PR106

Cutting width:	106 cm
Lawn area (rec.):	8.000 m ² /h
Collecting volume:	320
Engine:	Cub Cadet, V-TWIN dual cylinder
Engine displacement:	679 cm ³
Drive:	Hydrostatic
Cutting height adjustment:	12 positions
Model no.:	13AJA1TR603

Powered by
Kawasaki



XT2 QR106

Cutting width:	106 cm
Lawn area (rec.):	8.000 m ² /h
Collecting volume:	320 l
Engine:	Kawasaki, V-TWIN dual cylinder
Engine displacement:	726 cm ³
Drive:	Hydrostatic
Cutting height adjustment:	12 positions
Model no.:	13AFA1TR603

Powered by
Kawasaki



XT2 PS107

Cutting width:	107 cm
Lawn area (rec.):	8.500 m ² /h
Collecting volume:	Optional 200 l
Engine:	Kawasaki, V-TWIN dual cylinder
Engine displacement:	603 cm ³
Drive:	Hydrostatic
Cutting height adjustment:	12 positions
Model no.:	13AGA1TS603

POWERED BY
Cub Cadet



XT2 PS117

Cutting width:	117 cm
Lawn area (rec.):	9.000 m ² /h
Collecting volume:	Optional 200 l
Engine:	Cub Cadet, V-TWIN dual cylinder
Engine displacement:	679 cm ³
Drive:	Hydrostatic
Cutting height adjustment:	12 positions
Model no.:	13AJA1TT603

Powered by
Kawasaki



XT2 QS117

Cutting width:	117 cm, welded mowing deck
Lawn area (rec.):	9.000 m ² /h
Collecting volume:	Optional 200 l
Engine:	Kawasaki, V-TWIN dual cylinder
Engine displacement:	726 cm ³
Drive:	Hydrostatic
Cutting height adjustment:	12 positions
Model no.:	13AFA1TN603



POWERFUL
TWO-CYLINDER ENGINES



MASSIVE, WELDED
MOWING UNIT
(XT2 QS117)



XT2®

ENDURO SERIES®

XT3
ENDURO SERIES®

Cub Cadet
**TIGHT TURN
XTREME**



Just 17 cm turning radius thanks to TIGHT TURN XTREME.



Learn more

CENTRAL REAR DISCHARGE

All our rear discharge tractors are designed to transport grass clippings into the grass catcher with optimal efficiency. All XT Series rear discharge models feature a grass catcher made of durable fabric for flexibility and have an air passage to help air flow and collection.



360 L GRASS CATCHER



STRONG V-TWIN KAWASAKI ENGINE



ANTI-DUST SYSTEM

HYDROSTATIC POWER TRANSMISSION



HIGH TRACTION EVEN ON CHALLENGING TERRAIN



XT3 QR106

Cutting width:	106 cm
Lawn area (rec.):	8.000 m ² /h
Collecting volume:	360 l, with Anti dust system
Engine:	Kawasaki, V-TWIN dual cylinder
Engine displacement:	726 cm ³
Drive:	Hydrostatic, with differential lock
Cutting height adjustment:	12 positions
Model no.:	13AFA5TR603



XT3 QS127

Cutting width:	127 cm
Lawn area (rec.):	10.000 m ² /h
Collecting volume:	Optional 210 l
Engine:	Kawasaki, V-TWIN dual cylinder
Engine displacement:	726 cm ³
Drive:	Hydrostatic, with differential lock
Cutting height adjustment:	12 positions
Model no.:	14AFA5TQ603

XT1 OS96

XT1 OS107

ENGINE		
Engine type	Cub Cadet	Cub Cadet
Engine displacement	547 cm ³	547 cm ³
Rated power	9,0 kW / 2.300 min ⁻¹	6,6 kW / 2.250 min ⁻¹
Cylinders	Single	Single
Tank volume (capacity)	11,4 l	11,4 l
DRIVE SYSTEM		
Transmission	Hydrostatic	Hydrostatic
Speeds	Stepless (f/r)	Stepless (f/r)
Control	Foot pedal control	Foot pedal control
Cruise control	Standard	Standard
CUTTING SYSTEM		
Lawn area (rec./up to)	6.000 m ² /h	8.000 m ² /h
Cutting width	96 cm	107 cm
Cutting height (min-max)	25–100 mm	25–100 mm
Cutting deck	stamped	stamped
Number of blades	2	2
Deck engagement	Electric PTO	Electric PTO
Deck height positions	12 positions	12 positions
Deck wheels	2 balls deck wheels	2 balls deck wheels
Wash nozzle/Mulch Kit/mulching blades	–/Standard/Standard	Standard/Standard/Standard
DISCHARGE SYSTEM		
Bag (capacity)/accessory no.	Optional 200 l/(OEMR190-180A)	Optional 200 l/(19A30030100)
Bag lever/hardtop	–/–	–/–
Bag fill indicator/grass deflector	–/Standard	–/Standard
FRAME		
Front axle	Heavy-duty cast-iron	Heavy-duty cast-iron
Front bumper	Standard	Standard
Turning radius	TIGHT TURN 38 cm	TIGHT TURN 38 cm
Wheel size (f/r in inch)	15 x 6 / 20 x 8	15 x 6 / 20 x 8
Wheel bearings	Sleeve bearings	Sleeve bearings
Frame	Robotically-welded	Robotically-welded
ELECTRIC		
Headlights	LED	LED
COMFORT		
Seat type	Cut & Sew, high back rest	Cut & Sew, high back rest
Seat adjustment	Lever, angled, 10 slide	Lever, angled, 10 slide
Steering wheel	Ergonomic with gentle touch	Ergonomic with gentle touch
Toolbox/Cupholder	Standard/Standard	Standard/Standard
Mow-in-reverse	Standard	Standard
DIMENSIONS		
Noise level LpA/LwA/LwAg	88/98/100 dB (A)	88/98/100 dB (A)
Vibration value body / K-factor	1,0 / 0,5 m/s ²	1,0 / 0,5 m/s ²
Vibration value hand/arm / K-factor	5,0 / 1,5 m/s ²	5,0 / 1,5 m/s ²
Dimensions (L/W/H)	175 / 124 / 110 cm	175 / 134 / 110 cm
Net weight	195 kg	195 kg

Model number	13A8A1TF603	13A8A1TS603
EAN		

XT1 OR95

XT1 OR106

ENGINE		
Engine type	Cub Cadet	Cub Cadet
Engine displacement	547 cm ³	547 cm ³
Rated power	6,2 kW / 2.100 min ⁻¹	6,6 kW / 2.250 min ⁻¹
Cylinders	Single	Single
Tank volume (capacity)	11,4 l	11,4 l
DRIVE SYSTEM		
Transmission	Hydrostatic	Hydrostatic
Speeds	Stepless (f/r)	Stepless (f/r)
Control	Foot pedal control	Foot pedal control
Cruise control	Standard	Standard
CUTTING SYSTEM		
Lawn area (rec./up to)	5.500 m ² /h	7.500 m ² /h
Cutting width	95 cm	106 cm
Cutting height (min-max)	25–100 mm	25–100 mm
Cutting deck	stamped	stamped
Number of blades	2	2
Deck engagement	Electric PTO	Electric PTO
Deck height positions	12 positions	12 positions
Deck wheels	2 balls deck wheels	4 balls deck wheels
Wash nozzle/Mulch Kit/mulching blades	Standard/(196-551-000)/(196-561-000)	Standard/(196-550-000)/(196-560-000)
DISCHARGE SYSTEM		
Bag (capacity)/accessory no.	320 l/(196-555-603 Anti-Dust-System)	320 l/(196-555-603 Anti-Dust-System)
Bag lever/hardtop	Rounded ergo telescopic handle/Plastic	Rounded ergo telescopic handle/Plastic
Bag fill indicator/grass deflector	With Blade Shutoff/(196-552A000)	With Blade Shutoff/(196-552A000)
FRAME		
Front axle	Heavy-duty cast-iron	Heavy-duty cast-iron
Front bumper	Standard	Standard
Turning radius	TIGHT TURN 38 cm	TIGHT TURN 38 cm
Wheel size (f/r in inch)	15 x 6 / 18 x 8,5	15 x 6 / 18 x 8,5
Wheel bearings	Sleeve bearings	Sleeve bearings
Frame	Robotically-welded	Robotically-welded
ELECTRIC		
Headlights	LED	LED
COMFORT		
Seat type	Cut & Sew, high back rest	Cut & Sew, high back rest
Seat adjustment	Lever, angled, 10 slide	Lever, angled, 10 slide
Steering wheel	Ergonomic with gentle touch	Ergonomic with gentle touch
Toolbox/Cupholder	Standard/Standard	Standard/Standard
Mow-in-reverse	Standard	Standard
DIMENSIONS		
Noise level LpA/LwA/LwAg	88/98/100 dB (A)	88/98/100 dB (A)
Vibration value body / K-factor	1,0 / 0,5 m/s ²	1,0 / 0,5 m/s ²
Vibration value hand/arm / K-factor	5,0 / 1,5 m/s ²	5,0 / 1,5 m/s ²
Dimensions (L/W/H)	245 / 100 / 118 cm	245 / 110 / 118 cm
Net weight	235 kg	258 kg

Model number	13A8A1TB603	13A8A1TR603
EAN		

XT2 PR95

XT2 PR106

ENGINE		
Engine type	Kawasaki	Cub Cadet
Engine displacement	603 cm ³	679 cm ³
Rated power	9,3 kW / 2.150 min ⁻¹	14,9 kW / 2.150 min ⁻¹
Cylinders	V-TWIN dual cylinder	V-TWIN dual cylinder
Tank volume (capacity)	11,4 l	11,4 l
DRIVE SYSTEM		
Transmission	Hydrostatic	Hydrostatic
Speeds	Stepless (f/r)	Stepless (f/r)
Control	Foot pedal control	Foot pedal control
Cruise control	Standard	Standard
CUTTING SYSTEM		
Lawn area (rec./up to)	6.000 m ² /h	8.000 m ² /h
Cutting width	95 cm	106 cm
Cutting height (min-max)	25–100 mm	25–100 mm
Cutting deck	stamped	stamped
Number of blades	2	2
Deck engagement	Electric PTO	Electric PTO
Deck height positions	12 positions	12 positions
Deck wheels	2 balls deck wheels	4 balls deck wheels
Wash nozzle/Mulch Kit/mulching blades	Standard/(196-551-000)/(196-561-000)	Standard/(196-550-000)/(196-560-000)
DISCHARGE SYSTEM		
Bag (capacity)/accessory no.	320 l/(196-555-603 Anti-Dust-System)	320 l/(Anti-Dust-system 196-553-603)
Bag lever/hardtop	Rounded ergo telescopic handle/Plastic	Rounded ergo telescopic handle/Plastic
Bag fill indicator/grass deflector	With Blade Shutoff/(196-552A000)	With Blade Shutoff/(196-552A000)
FRAME		
Front axle	Heavy-duty cast-iron	Heavy-duty cast-iron
Front bumper	Standard, yellow	Standard, yellow
Turning radius	TIGHT TURN xTREME 17 cm	TIGHT TURN xTREME 17 cm
Wheel size (f/r in inch)	15 x 6 / 18 x 8,5	15 x 6 / 18 x 8,5
Wheel bearings	Sleeve bearings	Sleeve bearings
Frame	Robotically-welded	Robotically-welded
ELECTRIC		
Headlights	LED	LED
COMFORT		
Seat type	Cut & Sew, high back rest	Cut & Sew, high back rest
Seat adjustment	Lever, angled, 10 slide	Lever, angled, 10 slide
Steering wheel	Ergonomic with gentle touch	Ergonomic with gentle touch
Toolbox/Cupholder	Standard/Standard	Standard/Standard
Mow-in-reverse	Standard	Standard
DIMENSIONS		
Noise level LpA/LwA/LwAg	88/98/100 dB (A)	83/98/100 dB (A)
Vibration value body / K-factor	1,0 / 0,5 m/s ²	1,0 / 0,5 m/s ²
Vibration value hand/arm / K-factor	5,0 / 1,5 m/s ²	5,0 / 1,5 m/s ²
Dimensions (L/W/H)	250 / 100 / 118 cm	250 / 110 / 118 cm
Net weight	254 kg	253 kg
Model number	13AGA1TB603	13AJA1TR603
EAN	 4 008423 872279	 4 008423 922554

XT2 QR106

XT2 PS107

ENGINE		
Engine type	Kawasaki	Kawasaki
Engine displacement	726 cm ³	603 cm ³
Rated power	11,6 kW / 2.200 min ⁻¹	9,8 kW / 2.300 min ⁻¹
Cylinders	V-TWIN dual cylinder	V-TWIN dual cylinder
Tank volume (capacity)	11,4 l	11,4 l
DRIVE SYSTEM		
Transmission	Hydrostatic	Hydrostatic
Speeds	Stepless (f/r)	Stepless (f/r)
Control	Foot pedal control	Foot pedal control
Cruise control	Standard	Standard
CUTTING SYSTEM		
Lawn area (rec./up to)	8.000 m ² /h	8.500 m ² /h
Cutting width	106 cm	107 cm
Cutting height (min-max)	25–100 mm	25–100 mm
Cutting deck	stamped	stamped
Number of blades	2	2
Deck engagement	Electric PTO	Electric PTO
Deck height positions	12 positions	12 positions
Deck wheels	4 balls deck wheels	2 balls deck wheels
Wash nozzle/Mulch Kit/mulching blades	Standard/(196-550-000)/(196-560-000)	Standard/Standard/Standard
DISCHARGE SYSTEM		
Bag (capacity)/accessory no.	320 l/(196-555-603 Anti-Dust-System)	Optional 200 l/(19A30030100)
Bag lever/hardtop	Rounded ergo telescopic handle/Plastic	-/-
Bag fill indicator/grass deflector	With Blade Shutoff/(196-552A000)	-/Standard
FRAME		
Front axle	Heavy-duty cast-iron	Heavy-duty cast-iron
Front bumper	Standard, yellow	Standard, yellow
Turning radius	TIGHT TURN xTREME 17 cm	TIGHT TURN xTREME 17 cm
Wheel size (f/r in inch)	15 x 6 / 18 x 8,5	15 x 6 / 20 x 8
Wheel bearings	Sleeve bearings	Sleeve bearings
Frame	Robotically-welded	Robotically-welded
ELECTRIC		
Headlights	LED	LED
COMFORT		
Seat type	Cut & Sew, high back rest	Cut & Sew, high back rest
Seat adjustment	Lever, angled, 10 slide	Lever, angled, 10 slide
Steering wheel	Ergonomic with gentle touch	Ergonomic with gentle touch
Toolbox/Cupholder	Standard/Standard	Standard/Standard
Mow-in-reverse	Standard	Standard
DIMENSIONS		
Noise level LpA/LwA/LwAg	88/98/100 dB (A)	88/98/100 dB (A)
Vibration value body / K-factor	1,0 / 0,5 m/s ²	1,0 / 0,5 m/s ²
Vibration value hand/arm / K-factor	5,0 / 1,5 m/s ²	5,0 / 1,5 m/s ²
Dimensions (L/W/H)	250 / 110 / 118 cm	180 / 134 / 100 cm
Net weight	253 kg	210 kg
Model number	13AFA1TR603	13AGA1TS603
EAN	 4 008423 872262	 4 008423 872286

XT2 PS117

XT2 QS117

ENGINE		
Engine type	Cub Cadet	Kawasaki
Engine displacement	679 cm ³	726 cm ³
Rated power	14,9 kW / n.a. min ⁻¹	15,8 kW / n.a. min ⁻¹
Cylinders	V-TWIN dual cylinder	V-TWIN dual cylinder
Tank volume (capacity)	11,4 l	11,4 l
DRIVE SYSTEM		
Transmission	Hydrostatic	Hydrostatic
Speeds	Stepless (f/r)	Stepless (f/r)
Control	Foot pedal control	Foot pedal control
Cruise control	Standard	Standard
CUTTING SYSTEM		
Lawn area (rec./up to)	9.000 m ² /h	9.000 m ² /h
Cutting width	117 cm	117 cm
Cutting height (min-max)	25–100 mm	25–100 mm
Cutting deck	stamped	welded mowing deck
Number of blades	2	2
Deck engagement	Electric PTO	Electric PTO
Deck height positions	12 positions	12 positions
Deck wheels	4 balls deck wheels	4 balls deck wheels
Wash nozzle/Mulch Kit/mulching blades	Standard/Standard/Standard	Standard/Standard/Standard
DISCHARGE SYSTEM		
Bag (capacity)/accessory no.	Optional 200 l/(19A30030100)	Optional 200 l/(19A30030100)
Bag lever/hardtop	–/–	–/–
Bag fill indicator/grass deflector	–/Standard	–/Standard
FRAME		
Front axle	Heavy-duty cast-iron	Heavy-duty cast-iron
Front bumper	Standard, yellow	Standard, yellow
Turning radius	TIGHT TURN xTREME 17 cm	TIGHT TURN xTREME 17 cm
Wheel size (f/r in inch)	15 x 6 / 20 x 8,5	15 x 6 / 20 x 8,5
Wheel bearings	Sleeve bearings	Sleeve bearings
Frame	Robotically-welded	Robotically-welded
ELECTRIC		
Headlights	LED	LED
COMFORT		
Seat type	Cut & Sew, high back rest	Cut & Sew, high back rest
Seat adjustment	Lever, angled, 10 slide	Lever, angled, 10 slide
Steering wheel	Ergonomic with gentle touch	Ergonomic with gentle touch
Toolbox/Cupholder	Standard/Standard	Standard/Standard
Mow-in-reverse	Standard	Standard
DIMENSIONS		
Noise level LpA/LwA/LwAg	n.a./n.a./n.a. dB (A)	84,3/99,2/100,0 dB (A)
Vibration value body / K-factor	1,0 / 0,5 m/s ²	1,0 / 0,5 m/s ²
Vibration value hand/arm / K-factor	5,0 / 1,5 m/s ²	5,0 / 1,5 m/s ²
Dimensions (L/W/H)	180 / 146 / 110 cm	180 / 144 / 110 cm
Net weight	215 kg	230 kg

Model number	13AJA1TT603	13AFA1TN603
EAN	 4 008423 922592	 4 008423 922585

XT3 QR106

XT3 QS127

ENGINE		
Engine type	Kawasaki	Kawasaki
Engine displacement	726 cm ³	726 cm ³
Rated power	11,6 kW / 2.200 min ⁻¹	15,0 kW / 2.800 min ⁻¹
Cylinders	V-TWIN dual cylinder	V-TWIN dual cylinder
Tank volume (capacity)	11,4 l	11,4 l
DRIVE SYSTEM		
Transmission	Hydrostatic, with differential lock	Hydrostatic, with differential lock
Speeds	Stepless (f/r)	Stepless (f/r)
Control	Foot pedal control	Foot pedal control
Cruise control	Standard	Standard
CUTTING SYSTEM		
Lawn area (rec./up to)	8.000 m ² /h	10.000 m ² /h
Cutting width	106 cm	127 cm
Cutting height (min-max)	25–100 mm	25–100 mm
Cutting deck	stamped	stamped
Number of blades	2	3
Deck engagement	Electric PTO	Electric PTO
Deck height positions	12 positions	12 positions
Deck wheels	4 balls deck wheels	4 balls deck wheels + roller
Wash nozzle/Mulch Kit/mulching blades	Standard/(196-550-000)/(196-560-000)	Standard/Standard/Standard
DISCHARGE SYSTEM		
Bag (capacity)/accessory no.	360 l, with Anti dust system/–	Optional 210 l/(19A30018100)
Bag lever/hardtop	Rounded ergo telescopic handle/Plastic	–/–
Bag fill indicator/grass deflector	With Blade Shutoff/(196-552A000)	–/Standard
FRAME		
Front axle	Heavy-duty cast-iron	Heavy-duty cast-iron
Front bumper	Bull Bar	Bull Bar
Turning radius	TIGHT TURN xTREME 17 cm	TIGHT TURN xTREME 17 cm
Wheel size (f/r in inch)	15 x 6 / 18 x 8,5	16 x 6,5-8 / 22 x 9,5
Wheel bearings	Sleeve bearings	Ball bearings
Frame	Robotically-welded	Robotically-welded
ELECTRIC		
Headlights	LED	LED
COMFORT		
Seat type	Cut & Sew, high back rest, with arm rests	Cut & Sew, high back rest, with arm rests
Seat adjustment	Lever, angled, 10 slide	Lever, angled, 10 slide
Steering wheel	Ergonomic with gentle touch	Ergonomic with gentle touch
Toolbox/Cupholder	Standard/Standard	Standard/Standard
Mow-in-reverse	Standard	Standard
DIMENSIONS		
Noise level LpA/LwA/LwAg	88/98/100 dB (A)	93/103/105 dB (A)
Vibration value body / K-factor	1,0 / 0,5 m/s ²	1,0 / 0,5 m/s ²
Vibration value hand/arm / K-factor	5,0 / 1,5 m/s ²	5,0 / 1,5 m/s ²
Dimensions (L/W/H)	267 / 110 / 118 cm	197 / 155 / 110 cm
Net weight	268 kg	260 kg

Model number	13AFA5TR603	14AFA5TQ603
EAN	 4 008423 917499	 4 008423 915600

LAWN TRACTOR ACCESSORIES (EACH SOLD SEPARATELY)

	CUB CADET HAULER	
	Cub Cadet hauler with 450 kg load-bearing capacity	4 008423 887013 Mod. no.: 19B40026100R
	Handle	0 037049 959068 Mod. no.: 19A400270EM
	Tool holder	0 037049 959082 Mod. no.: 19A400300EM



HIGH LOAD CAPACITY
Rated to carry up to 450 kg with sides set upright and can easily haul soil or mulch, brick or stone, shrubs or plants, or even garbage bins.

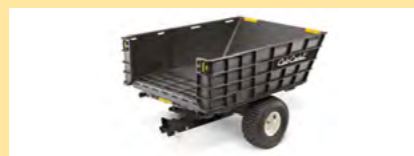

REMOVABLE PANELS
Easy access for loading, unloading and dumping.



VERSATILE – LETS YOU DO MORE. EASY FLAT-BED HAULING
Increase versatility by operating in fold-flat mode; ideal for longer loads like logs or lumber.



HANDLE AND TOOL HOLDER FOR CUB CADET HAULER

- Soft grip handle
- Flexible use
- Swift and simple assembly





FOLDABLE SIDES FOR EASY STORAGE
Collapse all four sides and store it vertically, taking up less space than traditional yard carts in a garage or shed.







TRANSPORT PLATFORM FOR XT SERIES SIDE DISCHARGER	
<ul style="list-style-type: none"> • Foldable vertically and lockable in place • Easy to install thanks to the FastAttach™ System • Max. weight: 36 kg • Suitable for XT Series side-dischargers 	0 043033 577132 Mod. no.: 19A30029100







ELECTRIC SPREADER FOR XT SERIES SIDE DISCHARGER	
<ul style="list-style-type: none"> • Easy to install thanks to the FastAttach™ System • Can be switched on/off from the driver's seat • Capacity: 45 kg • Suitable for XT Series side-dischargers 	4 008423 875775 Mod. no.: 19A30028100



	TOW BROADCAST SPREADER	
	<ul style="list-style-type: none"> • Capacity: 80 kg • Weight: 26 kg • Spreading width: up to 365 cm • Dimensions (L/W/H): 109 / 96,5 / 104 cm 	4 008423 816310 Mod. no.: 196-036-000
	<ul style="list-style-type: none"> • Capacity: 50 kg 	4 008423 874129 Mod. no.: 196-545-000
	<ul style="list-style-type: none"> • Capacity: 39 kg • Weight (approx.): 8 kg • Spreading width: up to 300 cm • Dimensions (L/W/H): 88,9 / 55,9 / 48,3 cm 	4 008423 875829 Mod. no.: 196-031B000



	LAWN TRACTOR COVER L/XL	
	Size L: for small- and medium-sized lawn tractors	4 008423 806441 Mod. no.: 2024-U1-0003
	Size XL: for large-sized and rear discharge lawn tractors (B)	4 008423 823882 Mod. no.: 2024-U1-0004







	UTILITY CART WITH POLY BED	
<ul style="list-style-type: none"> • Poly convertible push/tow cart, single-axle tipper • Capacity max.: 159 kg • Weight: 27 kg • Dimensions approx. (L/W/H): 142,2 / 83,8 / 76,2 cm 	4 008423 804331 Mod. no.: 190-236A000	
	<ul style="list-style-type: none"> • Poly convertible push/tow cart, single-axle tipper • Capacity max.: 175 kg • Weight: 30 kg 	4 008423 816396 Mod. no.: 196-506-000
	<ul style="list-style-type: none"> • Tow steel dump cart, single-axle tipper, removable tailgate • Capacity max.: 159 kg • Dimensions approx. (L/W/H): 152,4 / 83,8 / 72 cm • Weight (approx.): 33 kg 	4 016918 006894 Mod. no.: 190-223B000
	<ul style="list-style-type: none"> • Tow steel dump cart, single-axle tipper, removable tailgate • Capacity max.: 340 kg • Dimensions approx. (L/W/H): 177,8 / 83,8 / 73,7 cm • Weight (approx.): 70 kg 	4 008423 804348 Mod. no.: 196-507-000



	SPRAYER	
Tow sprayer, large, 6,8 l/min, capacity 95 l, dimensions approx. (L/W/H): 139,7 / 66 / 50,8 cm	4 008423 804430 Mod. no.: 190-537A000	

CUB CADET TOW BEHIND SWEEPER	
 <ul style="list-style-type: none"> Working width: 107 cm Catcher capacity: 380 litre Weight: 31,3 kg 	 4 008423 807516 Mod. no.: 190-163A000
<ul style="list-style-type: none"> Working width: 112 cm Catcher capacity: 736 litre 	 4 008423 858976 Mod. no.: 196-543-000



LAWN ROLLERS	
 <p>Push/tow poly lawn roller, max. weight 114 kg when filled with water, width 61 cm, diam. 46 cm, dimensions approx. (L/W/H): 127 / 76,2 / 46 cm</p>	 4 008423 401264 Mod. no.: 190-228-000
<p>Tow poly lawn roller, max. weight 182 kg when filled with water, width 91 cm, diam. 46 cm, dimensions approx. (L/W/H): 127 / 106,7 / 46 cm</p>	 4 008423 804478 Mod. no.: 190-229-000

AERATORS/DE-THATCHER	
 <p>Attachable lawn rake, working width 102 cm, 20 tines, variable load, dimensions (L/W/H): 104/101,6/104 cm</p>	 4 008423 804454 Mod. no.: 190-526-000
<p>Tow-Lawn Aerator, working width 102 cm, 10 galvanised aerator stars, variable load by additional loading, up to 6 cm aeration depth</p>	 4 008423 896367 Mod. no.: 196-094-000

MULCH KITS	
 <p>Mulch Kit (without blades) for model LT1 NS96 and LT2 NS96 (until 2022)</p>	 4 008423 819632 Mod. no.: OEM-190-116
<p>Mulch Kit (without blades) for models LT1 NR92, LT2 NR92 and LT3 PR105</p>	 4 008423 836080 Mod. no.: 196-749A678
 <p>Mulch Kit (without blade) for models XT1 OR106, XT2 QR106, XT2 PR106i and XT3 QR106, mulching plug optional available (196-560-000)</p>	 4 008423 875652 Mod. no.: 196-550-000
<p>Mulch Kit (without blade) for models XT1 OR95 and XT2 PR95, mulching plug optional available (196-561-000)</p>	 4 008423 875669 Mod. no.: 196-551-000

AGRICULTURAL TIRES	
 <p>Chevron style rear wheels 18" x 9,5". Set consists of 2 cpl. wheels. Fits all Cub Cadet tractors with either 18" or 20" rear wheels. Not approved for XT3 models.</p>	 4 008423 816891 Mod. no.: 196-721A678

GRASS CATCHER	
 <p>Anti-Dust-System for 360 l grass collection system, XT3 Series</p>	 4 008423 874976 Mod. no.: 196-553-603
<p>Anti-Dust-System for 320 l grass collection system, XT1 and XT2 Series</p>	 4 008423 875089 Mod. no.: 196-555-603
<p>Twin bagger, 200 l, for 96 cm / 107 cm decks of LT Series</p>	 4 008423 815849 Mod. no.: OEM-190-180A
<p>Provisional placeholder</p>	
<p>Twin bagger, 200 l, for 96 cm decks of XT Series</p>	 4 008423 883350 Mod. no.: OEMR190-180A
<p>Twin bagger, 200 l, for 107 / 117 cm, with variable tube, inspection window and FastAttach™ System, for decks of LT and XT Series</p>	 4 008423 879636 Mod. no.: 19A30030100
<p>Triple bagger, 210 l, for 127 / 137 cm decks of XT Series</p>	 0 037049 957286 Mod. no.: 19A30018100

FRONT BUMPER	
 <p>Front bumper, fits all LT Series lawn tractors</p>	 4 008423 917819 Mod. no.: OEM-190-679
<p>Front Bumper Bull Bar, XT Series</p>	 4 056494 171210 Mod. no.: 196-564-000

DEFLECTORS	
<p>Rear deflector for LT Series rear-discharger models</p>	 4 008423 836097 Mod. no.: 196-750A678
<p>Deflector for all XT series rear discharge lawnmowers</p>	 4 008423 899641 Mod. no.: 196-552A000

REAR HITCH	
<p>Rear hitch for LT series with rear discharge</p>	 4 008423 914733 Mod. no.: 196-399-000

TIELBÜRGER FRONT ATTACHMENT SWEEPER AND ACCESSORIES (RE=REQUIRED | OP=OPTIONAL)



	Front attachment sweeper, 120 cm. Accessories for mounting are required. See below.	 4 008423 883510 Mod. no.: 196-603-000
	OP: Hopper for front attachment sweeper	 4 008423 883527 Mod. no.: 196-604-000
	RE: Quick-action coupling system with drive – attachment for front attachment sweeper and premium dozer blade	 4 008423 883503 Mod. no.: 196-602-000
	RE: For rear discharge Drive line	 4 008423 885194 Mod. no.: 196-608-000
	RE: For side discharge Drive line (up to and including date of manufacture 2017)	 4 008423 885200 Mod. no.: 196-609-000
	RE: For rear discharge Add-on parts	 4 008423 885217 Mod. no.: 196-610-000
	RE: For side discharge Add-on parts (up to and including date of manufacture 2017)	 4 008423 885224 Mod. no.: 196-611-000

TIELBÜRGER PREMIUM DOZER BLADE AND ACCESSORIES (RE=REQUIRED | OP=OPTIONAL)

	Premium dozer blade, 125 cm. Accessories for mounting are required. See below.	 4 008423 883534 Mod. no.: 196-606-000
	OP: Wheels for Premium dozer blade	 4 008423 883541 Mod. no.: 196-607-000
	RE: Quick-action coupling system without drive – attachment for premium dozer blade	 4 008423 883497 Mod. no.: 196-601-000
	OP: Quick-action coupling system with drive – attachment for front attachment sweeper and premium dozer blade	 4 008423 883503 Mod. no.: 196-602-000
	RE: For rear discharge Add-on parts	 4 008423 885217 Mod. no.: 196-610-000
	RE: For side discharge Add-on parts (up to and including date of manufacture 2017)	 4 008423 885224 Mod. no.: 196-611-000







TIRE CHAINS





For 20" x 8,0" wheels incl. Adapter	 4 008423 824797 Mod. no.: 196-658-699
For 18" x 9,5" wheels incl. Adapter	 4 008423 813678 Mod. no.: 196-898-699
For XT 22" x 9,5" x 12" and 23" x 9,5" x 12" wheels	 0 037049 945597 Mod. no.: 490-241-0025



DOZER BLADE AND RUBBER LIP

117 cm dozer blade for LT Series	 4 008423 807684 Mod. no.: OEM-190-833
Rubber lip – universal – for for dozer blade OEM-190-833 and 19A30017OEM	 4 008423 815368 Mod. no.: 196-718-678
117 cm dozer blade for LT und XT Series	 0 037049 957309 Mod. no.: 19A30017OEM
Installation Kit – for attaching OEM-190-833 in the XT Series	 4 008423 879629 Mod. no.: 196-584-000

ADDITIONAL XT ACCESSORIES

Battery charger for LR, LT and XT Series	 4 008423 835694 Mod.-Nr.: 196-967-678
Electrical grass catcher emptying mechanism for XT Series rear discharger system. Only suitable for 2018 and later models.	 4 008423 882025 Mod.-Nr.: 196-570-600
Mounted snow thrower for XT Series side discharger, 107 cm, 3-stepped	 0 043033 573585 Mod.-Nr.: 19A40024100
Mounted snow thrower for XT Series rear discharger, 107 cm, 3-stepped	 0 016918 038936 Mod.-Nr.: 19A40045OEM
Fuel canister, 10 litre	 4 008423 877540 Mod.-Nr.: 196-558-603

XZ6

ENDURO SERIES®



SYNCHRO STEER® TECHNOLOGY

GOOD MANOEUVRABILITY AND SLOPE HANDLING

The Cub Cadet Synchro Steer® Technology is the next step of the evolution of the Zero-Turn technique. Our unique Zero-Turn riders with a traditional steering wheel provide you with the amazing manoeuvrability of a conventional Zero-Turn but retaining control of the front wheels. Steering and drive are synchronized to help control the speed and rotation direction of each rear wheel, whatever the position of the front wheels. This technology is available for the XZ6 and the new XZ8 Series.



ZERO TURNING RADIUS – GREAT VARIETY

High-performance meets practicality for one strong rider. The industry's first Zero-Turn system with steering wheel control and four-wheel steering for strength and stability. From the power of a professional-grade engine to its efficiency and durability, designed for each mow to be as strong as the last.

- ADJUSTABLE STEERING COLUMN**
- COMFORTABLE SEAT WITH ARMRESTS**
- BRIGHT LED HEADLIGHTS**
Helps provide visibility in poor lighting conditions, e.g. at dawn and dusk.
- ROBUST TUBULAR STEEL FRAME**
- SOLID, WELDED MOWER DECKS**
For high durability and robustness.
- PNEUMATIC CASTER WHEELS**
Controllable pneumatic front caster wheels which support the Zero-Turn of your XZ.
- CLEAN CUT**
The floating deck follows ground contours for excellent cutting and a smooth and uniform look.
- FOOT CONTROLLED DECK LIFT**
Adjust the mowing height in 15 steps with the convenient rotary knob.



XZ6 S107

Cutting width:	107 cm
Lawn area (rec.):	10.000 m ² /h
Collecting volume:	Optional 230 l
Engine:	Cub Cadet, V-TWIN dual cylinder
Engine displacement:	679 cm ³
Drive:	Dual Hydrostatic
Cutting height adjustment:	15 positions
Model no.:	17AAGBYE603



XZ6 S117

Cutting width:	117 cm
Lawn area (rec.):	10.500 m ² /h
Collecting volume:	Optional 230 l
Engine:	Kawasaki, V-TWIN dual cylinder
Engine displacement:	726 cm ³
Drive:	Dual Hydrostatic
Cutting height adjustment:	15 positions
Model no.:	17AIGBYN603



XZ6 S127

Cutting width:	127 cm
Lawn area (rec.):	11.500 m ² /h
Collecting volume:	Optional 230 l
Engine:	Kawasaki, V-TWIN dual cylinder
Engine displacement:	726 cm ³
Drive:	Dual Hydrostatic
Cutting height adjustment:	15 positions
Model no.:	17AIGGY2603



Learn more

NEW

CONQUER THE HILLS!

Steering wheel control is something we all are familiar with. The concept of maintaining your terrain from a comfortable and solid position is the basis of the innovative Synchro Steer® Technology we offer exclusively for our Zero-Turn mowers. The new XZ8 series is engineered to mow your lawn precisely and help prevent turf damage – even on sloping terrain. With its robust steel frame and its durable design you can now feel even more confident on challenging terrains.

XZ8
ENDURO SERIES®



Placeholder



SYNCHRO STEER® TECHNOLOGY

GOOD MANOEVRABILITY AND SLOPE HANDLING

The Cub Cadet Synchro Steer® Technology is the next step of the evolution of the Zero-Turn technique. Our unique Zero-Turn riders with a traditional steering wheel provide you with the amazing manoeuvrability of a conventional Zero-Turn but retaining control of the front wheels. Steering and drive are synchronized to help control the speed and rotation direction of each rear wheel, whatever the position of the front wheels. This technology is available for the XZ6 and the new XZ8 Series.



SOLID ROLLOVER PROTECTION
Fully welded tubular steel frame already as standard equipment.

TUBULAR STEEL FRAME
Designed for high durability and a long lifetime.

FABRICATED MOWING DECKS
Designed for high performance and resistance.

PREMIUM HIGH BACK SEAT
Offers high comfort.

FOOT CONTROLLED DECK LIFT
Adjust the mowing height in 16 steps with the convenient rotary knob.

HYDRO DRIVE SYSTEM
Helps provide a smooth mowing experience.



Image similar



Placeholder



XZ8 S122 - ULTIMA

Cutting width:	122 cm
Lawn area (rec.):	11.000 m ² /h
Collecting volume:	Optional 380 l
Engine:	Kawasaki, V-TWIN dual cylinder
Engine displacement:	726 cm ³
Drive:	Dual Hydrostatic, Hydrogear ZT3100
Cutting height adjustment:	16 positions
Model no.:	47AICAB6603

XZ8 S137i - ULTIMA

Cutting width:	137 cm
Lawn area (rec.):	13.000 m ² /h
Collecting volume:	Optional 380 l
Engine:	KOHLER EFI, V-TWIN dual cylinder
Engine displacement:	726 cm ³
Drive:	Dual Hydrostatic, Hydrogear ZT3200
Cutting height adjustment:	16 positions
Model no.:	47ATCAB7603



DURABILITY
We trust our new XZ8 models with high durability and robustness and offer a warranty of 3 years or up to 500 working hours* – for commercial or private use. *Whichever comes first

XZ5

ENDURO SERIES®



ENJOY YOUR PRECISE CONTROL

Our lap-bar technology combined with the robust construction consisting of heavy-duty components and high-performance engines help make the XZ5 Series the ideal solution for large lawn areas.

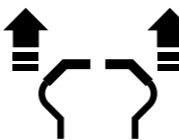

DRIVING FORWARD

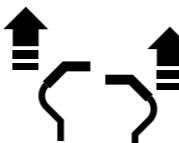

TURNING TO THE RIGHT

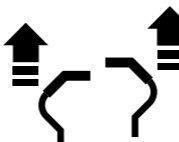

TURNING TO THE LEFT



DRIVING REVERSE

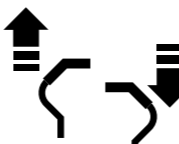

EXECUTING A ZERO-TURN

POWERFUL ENGINES

Driven by powerful Cub Cadet or Kawasaki engines, the XZ5 models reach speeds of up to 12 km/h.

LOW VIBRATION

With soft grips and rubber floor mats.

LARGE TIRES FOR GOOD TRACTION

The tires of the XZ5 127 and XZ5 137 models help provide traction. They also offer stability and control.

INDIVIDUALLY ADJUSTABLE SEAT

With high back and armrests for comfort and to help minimize fatigue.

BRIGHT LED HEADLIGHTS

Helps provide visibility in poor lighting conditions, e.g. at dawn and dusk.

RUGGED MOWING DECKS

The XZ5 models have an robust steel mowing deck and a lightweight tubular steel frame.



FOOT CONTROLLED DECK LIFT

Adjust the mowing height in 15 steps with the convenient rotary knob.



XZ5 L107 - ULTIMA

Cutting width:	107 cm
Lawn area (rec.):	10.000 m ² /h
Collecting volume:	Optional 230 l
Engine:	Cub Cadet, V-TWIN dual cylinder
Engine displacement:	679 cm ³
Drive:	Dual Hydrostatic
Cutting height adjustment:	15 positions
Model no.:	17BAEACS603



XZ5 L127 - ULTIMA

Cutting width:	127 cm
Lawn area (rec.):	11.500 m ² /h
Collecting volume:	Optional 230 l
Engine:	Kawasaki OHV, V-TWIN dual cylinder
Engine displacement:	726 cm ³
Drive:	Dual Hydrostatic
Cutting height adjustment:	15 positions
Model no.:	17AIEACL603



XZ5 L137 - ULTIMA

Cutting width:	137 cm
Lawn area (rec.):	12.500 m ² /h
Collecting volume:	Optional 230 l
Engine:	Kawasaki OHV, V-TWIN dual cylinder
Engine displacement:	726 cm ³
Drive:	Dual Hydrostatic
Cutting height adjustment:	15 positions
Model no.:	17AIEAC3603



Learn more

XZ7

ENDURO SERIES®

DESIGNED FOR YOUR CHALLENGES

The XZ7 Series makes a great impression with its improved stability and durability. You can easily mow with high comfort even under the tough conditions.



VERSATILITY

In addition to the included mulching kit the standard rear hitch gives you the option to combine your XZ7 with a wide variety of accessories.

HIGH COMFORT

The premium seat with a high backrest has padded armrests and special cushioning.

FOOT CONTROLLED DECK LIFT

Adjust the mowing height in 16 steps with the convenient rotary knob.



ROBUST MOWING DECK

The robust tubular steel frame as well as the welded, all-round reinforced AeroForce Max™ mowing deck provides the necessary strength for a consistently high cut quality.

SPRING-MOUNTED FRONT-WHEEL SUSPENSION

The individually-suspended wheels help for a smooth ride with less vibration, even on difficult lawns.



TOP SPEED

With a top speed of up to 14,5 km/h, you can mow even large areas in no time.



BRIGHT LED HEADLIGHTS

Helps provide visibility in poor lighting conditions, e.g. at dawn and dusk.

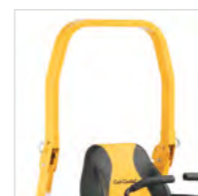

SOLID ROLLOVER PROTECTION

Fully welded tubular steel frame as standard equipment.



3-in-1
OPTION
Powered by
KAWASAKI

XZ7 L122 - ULTIMA

Cutting width:	122 cm
Lawn area (rec.):	11.000 m ² /h
Collecting volume:	Optional 380 l
Engine:	Kawasaki, V-TWIN dual cylinder
Engine displacement:	726 cm ³
Drive:	Dual Hydrostatic
Cutting height adjustment:	16 positions
Model no.:	47AIAAA6603



3-in-1
OPTION
POWERED BY
KOHLER

XZ7 L152i - ULTIMA

Cutting width:	152 cm
Lawn area (rec.):	15.000 m ² /h
Collecting volume:	Optional 380 l
Engine:	KOHLER EFI, V-TWIN dual cylinder
Engine displacement:	747 cm ³
Drive:	Dual Hydrostatic
Cutting height adjustment:	16 positions
Model no.:	47ATAHA8603



DURABILITY

We trust our new XZ7 models with high durability and robustness and offer a warranty of 3 years or up to 500 working hours* – for commercial or private use. *Whichever comes first



Learn more

XZ5 L107 - ULTIMA

LAP-BAR TECHNOLOGY

XZ5 L127 - ULTIMA

LAP-BAR TECHNOLOGY



ENGINE		
Engine type	Cub Cadet	Kawasaki OHV
Engine displacement	679 cm ³	726 cm ³
Rated power	11,4 kW / 2.350 min ⁻¹	14,1 kW / 2.800 min ⁻¹
Cylinders	V-TWIN dual cylinder	V-TWIN dual cylinder
Tank volume (capacity)	13,25 l	13,25 l
Lubrication	Full-pressure with spin-on oil filter	Full-pressure with spin-on oil filter
DRIVE SYSTEM		
Transmission	Dual Hydrostatic	Dual Hydrostatic
Control	Control lever	Control lever
Cruise control	-	-
CUTTING SYSTEM		
Lawn area (rec./up to)	10.000 m ² /h	11.500 m ² /h
Cutting width	107 cm	127 cm
Cutting height (min-max)	25-115 mm	25-115 mm
Cutting options	3-in-1 Option	3-in-1 Option
Number of blades	2	3
Deck engagement	Electric PTO	Electric PTO
Deck height positions	15 positions	15 positions
Deck wheels	2	3
Wash nozzle/Mulch Kit	Standard/Standard	Standard/Standard
DISCHARGE SYSTEM		
Bag (capacity in l)/accessory no.	Optional 230 l/(19A70054100)	Optional 230 l/(19A70055100)
Grass deflector	Standard	Standard
FRAME		
Front axle	Steel	Steel
Front bumper/rear bumper	- / Tubular steel frame	- / Tubular steel frame
Turning radius (cm)	0 cm	0 cm
Wheel size (f/r in inch)	11 x 6 / 20 x 8	11 x 6 / 20 x 10
Wheel bearings	-	-
ELECTRICAL SYSTEM		
Battery	12 V / 230 CCA	12 V / 230 CCA
Headlights	LED	LED
Hour metre/service minder	-	-
Safety systems	Standard	-
COMFORT		
Seat type	High back, with arm rests	High back with armrests
Seat adjustment	Quick adjuster lever	Quick adjuster lever
Steering technology	2-way adjustable lap bars with comfort grips	2-way adjustable lap bars with comfort grips
Utility bin	Standard	Standard
Mow-in-reverse	Standard	Standard
DIMENSIONS		
Noise level LpA/LwA/LwAg	88/98/100 dB (A)	93/103/105 dB (A)
Vibration value body/K-factor	1,0 / 0,5 m/s ²	1,0 / 0,5 m/s ²
Vibration value hand/arm / K-factor	5,0 / 1,5 m/s ²	5,0 / 1,5 m/s ²
Dimensions (L/W/H)	203 / 132 / 114 cm	203 / 155 / 114 cm
Net weight	267 kg	285 kg
Model number	17BAEACS603	17AIEACL603
EAN		

XZ5 L137 - ULTIMA

LAP-BAR TECHNOLOGY

XZ6 S107

STEERING WHEEL TECHNOLOGY

ENGINE		
Engine type	Kawasaki OHV	Cub Cadet
Engine displacement	726 cm ³	679 cm ³
Rated power	14,7 kW / 2.900 min ⁻¹	14,9 kW / n.a. min ⁻¹
Cylinders	V-TWIN dual cylinder	V-TWIN dual cylinder
Tank volume (capacity)	13,25 l	13,25 l
Lubrication	Full-pressure with spin-on oil filter	Full-pressure with spin-on oil filter
DRIVE SYSTEM		
Transmission	Dual Hydrostatic	Dual Hydrostatic
Control	Control lever	Dual foot pedal control
Cruise control	-	-
CUTTING SYSTEM		
Lawn area (rec./up to)	12.500 m ² /h	10.000 m ² /h
Cutting width	137 cm	107 cm
Cutting height (min-max)	25-115 mm	25-114 mm
Cutting options	3-in-1 Option	3-in-1 option
Number of blades	3	2
Deck engagement	Electric PTO	Electric PTO
Deck height positions	15 positions	15 positions
Deck wheels	3	2
Wash nozzle/Mulch Kit	Standard/Standard	-/Standard
DISCHARGE SYSTEM		
Bag (capacity in l)/accessory no.	Optional 230 l/(19A70055100)	Optional 230 l/(19A70054100 + 490-950-C062)
Grass deflector	Standard	Standard
FRAME		
Front axle	Steel	Steel
Front bumper/rear bumper	- / Tubular steel frame	- / -
Turning radius (cm)	0 cm	0 cm
Wheel size (f/r in inch)	13 x 6,5 / 20 x 12	13 x 6,5 / 20 x 8
Wheel bearings	-	Sleeve bearings
ELECTRICAL SYSTEM		
Battery	12 V / 230 CCA	12 V / 230 CCA
Headlights	LED	-
Hour metre/service minder	Standard	Standard
Safety systems	Standard	Operator presence, brake switch, deck clutch switch
COMFORT		
Seat type	High back with armrests	High back with arm rests
Seat adjustment	Quick adjuster lever	Quick adjuster lever
Steering technology	2-way adjustable lap bars with comfort grips	Soft-Grip steering wheel, tilt steering column
Utility bin	Standard	Standard
Mow-in-reverse	Standard	Standard
DIMENSIONS		
Noise level LpA/LwA/LwAg	93/103/105 dB (A)	n.a/n.a/n.a dB (A)
Vibration value body/K-factor	1,0 / 0,5 m/s ²	1,0 / 0,5 m/s ²
Vibration value hand/arm / K-factor	5,0 / 1,5 m/s ²	5,0 / 1,5 m/s ²
Dimensions (L/W/H)	203 / 164 / 117 cm	203 / 132 / 114 cm
Net weight	312 kg	267 kg
Model number	17AIEAC3603	17AAGBYE603
EAN		

XZ6 S117 STEERING WHEEL TECHNOLOGY

XZ6 S127 STEERING WHEEL TECHNOLOGY

ENGINE		
Engine type	Kawasaki	Kawasaki
Engine displacement	726 cm ³	726 cm ³
Rated power	16,9 kW / n.a. min ⁻¹	14,5 kW / 2.800 min ⁻¹
Cylinders	V-TWIN dual cylinder	V-TWIN dual cylinder
Tank volume (capacity)	13,25 l	13,25 l
Lubrication	Full-pressure with spin-on oil filter	Full-pressure with spin-on oil filter
DRIVE SYSTEM		
Transmission	Dual Hydrostatic	Dual Hydrostatic
Control	Dual foot pedal control	Dual foot pedal control
Cruise control	-	-
CUTTING SYSTEM		
Lawn area (rec./up to)	10.500 m ² /h	11.500 m ² /h
Cutting width	117 cm	127 cm
Cutting height (min-max)	25–114 mm	25–114 mm
Cutting options	3-in-1 option	3-in-1 Option
Number of blades	2	3
Deck engagement	Electric PTO	Electric PTO
Deck height positions	15 positions	15 positions
Deck wheels	2	3
Wash nozzle/Mulch Kit	-/Standard	-/Standard
DISCHARGE SYSTEM		
Bag (capacity in l)/accessory no.	Optional 230 l/(19A70054100 + 490-950-C062)	Optional 230 l/(19A70054100 + 490-950-C062)
Grass deflector	Standard	Standard
FRAME		
Front axle	Steel	Steel
Front bumper/rear bumper	-/-	-/-
Turning radius (cm)	0 cm	0 cm
Wheel size (f/r in inch)	13 x 6,5 / 20 x 10	13 x 6,5 / 20 x 12
Wheel bearings	Sleeve bearings	Ball-bearings
ELECTRICAL SYSTEM		
Battery	12 V / 230 CCA	12 V / 230 CCA
Headlights	-	-
Hour metre/service minder	Standard	Standard
Safety systems	Operator presence, brake switch, deck clutch switch	Operator presence, brake switch, deck clutch switch
COMFORT		
Seat type	High back, with arm rests	High back, with arm rests
Seat adjustment	Quick adjuster lever	Quick adjuster lever
Steering technology	Soft-Grip steering wheel, tilt steering column	Soft-Grip steering wheel, tilt steering column
Utility bin	Standard	Standard
Mow-in-reverse	Standard	Standard
DIMENSIONS		
Noise level LpA/LwA/LwAg	n.a./n.a./n.a. dB (A)	n.a./n.a./n.a. dB (A)
Vibration value body/K-factor	1,0 / 0,5 m/s ²	1,0 / 0,5 m/s ²
Vibration value hand/arm / K-factor	5,0 / 1,5 m/s ²	5,0 / 1,5 m/s ²
Dimensions (L/W/H)	203 / 155 / 114 cm	203 / 126 / 118 cm
Net weight	285 kg	265 kg
Model number	17AIGBYN603	17AIGGY2603
EAN	4 008423 922684	4 008423 922691

XZ7 L122 - ULTIMA LAP-BAR TECHNOLOGY

XZ7 L152i - ULTIMA LAP-BAR TECHNOLOGY

ENGINE		
Engine type	Kawasaki	KOHLER EFI
Engine displacement	726 cm ³	747 cm ³
Rated power	14,4 kW / 2.700 min ⁻¹	14,8 kW / 2.700 min ⁻¹
Cylinders	V-TWIN dual cylinder	V-TWIN dual cylinder
Tank volume (capacity)	20,8 l	20,8 l
Lubrication	Full-pressure with spin-on oil filter	Full-pressure with spin-on oil filter
DRIVE SYSTEM		
Transmission	Dual Hydrostatic	Dual Hydrostatic
Control	Control lever	Control lever
Cruise control	-	Standard
CUTTING SYSTEM		
Lawn area (rec./up to)	11.000 m ² /h	15.000 m ² /h
Cutting width	122 cm	152 cm
Cutting height (min-max)	25–114 mm	25–114 mm
Cutting options	3-in-1 option	3-in-1 option
Number of blades	3	3
Deck engagement	Electric PTO	Electric PTO
Deck height positions	16 positions	16 positions
Deck wheels	2	2 + Nose
Wash nozzle/Mulch Kit	-/Standard	-/Standard
DISCHARGE SYSTEM		
Bag (capacity in l)/accessory no.	Optional 380 l/(49A70001100)	Optional 380 l/(49A70002100)
Grass deflector	Standard	Standard
FRAME		
Front axle	Steel, with front wheel suspension	Steel, with front wheel suspension
Front bumper/rear bumper	- / Tubular steel frame	- / Tubular steel frame
Turning radius (cm)	0 cm	0 cm
Wheel size (f/r in inch)	13 x 6,5 / 23 x 12	13 x 6,5 / 24 x 12
Wheel bearings	n.a.	n.a.
ELECTRICAL SYSTEM		
Battery	12 V / 230 CCA	12 V / 230 CCA
Headlights	LED	LED
Hour metre/service minder	Standard	Standard
Safety systems	Standard	Standard
COMFORT		
Seat type	Premium, high back with armrests, individually adjustable suspension	Premium, high back with armrests, individually adjustable suspension
Seat adjustment	Quick adjuster lever	Quick adjuster lever
Steering technology	2-way adjustable lap bars with comfort grips	2-way adjustable lap bars with comfort grips
Utility bin	Standard	Standard
Mow-in-reverse	Standard	Standard
DIMENSIONS		
Noise level LpA/LwA/LwAg	93/103/105 dB (A)	93/103/105 dB (A)
Vibration value body/K-factor	1,0 / 0,5 m/s ²	1,0 / 0,5 m/s ²
Vibration value hand/arm / K-factor	5,0 / 1,5 m/s ²	5,0 / 1,5 m/s ²
Dimensions (L/W/H)	232 / 145 / 134 cm	233 / 177 / 134 cm
Net weight	415 kg	450 kg
Model number	47AIAAA6603	47ATAHA8603
EAN	4 008423 916805	4 008423 916812

NEW

XZ8 S122 - ULTIMA STEERING WHEEL TECHNOLOGY

NEW





XZ8 S137i - ULTIMA STEERING WHEEL TECHNOLOGY

ENGINE		
Engine type	Kawasaki	KOHLER EFI
Engine displacement	726 cm ³	747 cm ³
Rated power	14,4 kW / 2.700 min ⁻¹	n.a. kW / n.a. min ⁻¹
Cylinders	V-TWIN dual cylinder	V-TWIN dual cylinder
Tank volume (capacity)	20,8 l	20,8 l
Lubrication	Full-pressure with spin-on oil filter	Full-pressure with spin-on oil filter
DRIVE SYSTEM		
Transmission	Dual Hydrostatic (Hydregear ZT3100)	Dual Hydrostatic (Hydregear ZT3200)
Control	Dual foot pedal control	Dual foot pedal control
Cruise control	-	-
CUTTING SYSTEM		
Lawn area (rec./up to)	11.000 m ² /h	13.000 m ² /h
Cutting width	122 cm	137 cm
Cutting height (min-max)	25-114 mm	25-114 mm
Cutting options	3-in-1 option	3-in-1 option
Number of blades	3	3
Deck engagement	Electric PTO	Electric PTO
Deck height positions	16 positions	16 positions
Deck wheels	2	2
Wash nozzle/Mulch Kit	-/Standard	-/Standard
DISCHARGE SYSTEM		
Bag (capacity in l)/accessory no.	Optional 380 l/(49A70001100 + 490-950-C062)	Optional 380 l/(49A70002100 + 490-950-C062)
Grass deflector	Standard	Standard
FRAME		
Front axle	Steel	Steel
Front bumper/rear bumper	- / Standard	- / Standard
Turning radius (cm)	0 cm	0 cm
Wheel size (f/r in inch)	13 x 6,5 / 22 x 12	13 x 6,5 / 23 x 12
Wheel bearings	-	-
ELECTRICAL SYSTEM		
Battery	210cca AGM	210cca AGM
Headlights	LED	LED
Hour metre/service minder	Standard	Standard
Safety systems	Standard	Standard
COMFORT		
Seat type	High back with armrests, individually adjustable suspension	High back with armrests, individually adjustable suspension
Seat adjustment	Quick adjuster lever	Quick adjuster lever
Steering technology	Soft-Grip steering wheel, tilt steering column	Soft-Grip steering wheel, tilt steering column
Utility bin	Standard	Standard
Mow-in-reverse	Standard	Standard
DIMENSIONS		
Noise level LpA/LwA/LwAg	n.a./n.a./n.a. dB (A)	n.a./n.a./n.a. dB (A)
Vibration value body/K-factor	1,0 / 0,5 m/s ²	1,0 / 0,5 m/s ²
Vibration value hand/arm / K-factor	5,0 / 1,5 m/s ²	5,0 / 1,5 m/s ²
Dimensions (L/W/H)	n.a./n.a./n.a. cm	n.a./n.a./n.a. cm
Net weight	n.a.	n.a.
Model number	47AICAB6603	47ATCAB7603
EAN	 4 008423 924459	 4 008423 924466

ZERO-TURNS ACCESSORIES



GRASS CATCHER

Twin bagger, 200 l, for XZ2 117i		Mod. no.: 19C70020100
Twin bagger, 200 l, for XZ2 127		Mod. no.: 19A70043100
Triple bagger, 300 l, for XZ3 122		Mod. no.: 19A70040100
Cub Cadet RZT Twin Bagger, 107 cm, 230 litres for XZ5 and XZ6 (XZ6 requires the additional weight kit 490-950-C062)		Mod. no.: 19A70054100
Cub Cadet RZT Twin Bagger, 127 / 137 cm, 230 litres for XZ5 and XZ6 (XZ6 requires the additional weight kit 490-950-C062)		Mod.-Nr.: 19A70055100
Triple Bagger 380 l, for XZ7 and XZ8 with 122cm cutting width (XZ8 requires the additional weight kit 490-950-C062)		Mod.-Nr.: 49A70001100
Triple Bagger 380 l, for XZ7 and XZ8 with 137 cm or 152 cm cutting width (XZ8 requires the additional weight kit 490-950-C062)		Mod. no.: 49A70002100
Weight kit for use with the grass catcher of all XZ6 and XZ8 models		Mod. no.: 490-950-C062



HITCH / XZ

Hitch for all XZ models		Mod. no.: 19A70025100
-------------------------	---	-----------------------





PRO Z SERIES



DURABILITY – HEAVY DUTY

From the frame to the front yoke, every part of the PRO Z is designed to handle serious rigors. The thickness of the cutting deck and the all-around heavy-duty construction will help this Zero-Turn last for the long haul.

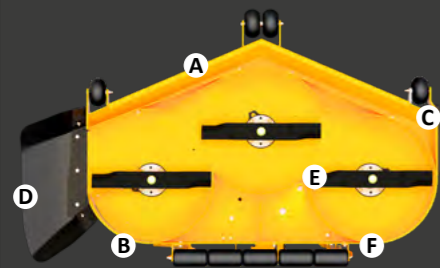

DURABILITY

- A** 1/4" leading rolled edge
- B** 5/16" steel side reinforcements
- C** 3/4" wear guard

QUALITY CUT

- D** Flexible rubber discharge chute
- E** High-lift Marbain® blades (with blade tip speed up to 18,500 fpm)
- F** Adjustable rear stripping roller

BEEFED-UP FRONT END

Designed to absorb the impact of rough terrain with a front-end construction featuring a outstanding combination of axle, hub and yoke size.



- A** 2" x 3" pivoting front axle
- B** Isolation damping system
- C** 5" steel hubs
- D** 1/2" thick steel front yokes



COMFORT – WORK HARD. RIDE EASY

The PRO Z can take a beating, but your body shouldn't. Enjoy a smooth ride throughout the day long with the comfort features of the PRO Z Series.



PRO Z AIR-RIDE SEAT

Our air-ride seat allows riders to adjust the seat firmness to their personal preference.

- A** Isolation damping system under the seat (PRO Z 5/7/9)
- B** Lumbar support
- C** EVC cushion (elastic vibration control)
- D** Angle adjustment
- E** Padded armrests



PIVOTING FRONT AXLE

A pivoting front axle allows the front end of the PRO Z to negotiate unseen terrain while helping to protect the quality of the cut. The frame and axle float as the PRO Z moves, allowing the deck to follow the terrain profile and minimize scalping.



KAWASAKI OHV
V-TWIN DUAL CYLINDER

Z5 152 & Z7 183

Amazing strength and outstanding comfort – the perfect combination for true professionals! The Z5 152 offers performance, quality and efficiency that put other leading Zero-Turn mowers in the shade. The Z7 183 is in the range of our top models that needs much less mowing time than other Cub Cadet products. However much you demand from a mower, you will love it!



KAWASAKI 31 HP ENGINE
A super-strong and efficient drive to meet optimal requirements (Z7 183).

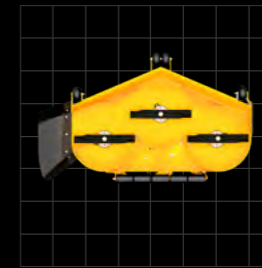

OUTSTANDING MOWING DECK
With its massive cutting width of 183 cm (Z7 183).

Z5 152

STRENGTH IN EVERY DETAIL.



Powered by
Kawasaki

Cutting width:	152 cm
Area performance (rec.):	15.000 m ² /h
Discharge type:	Side discharge
Engine:	Kawasaki OHV, V-TWIN dual cylinder
Engine displacement:	852 cm ³
Drive:	Dual Hydrostatic
Transmission:	Parker HTG 12 cc
Max. speed:	16 km/h (forward)/8 km/h (reverse)
Cutting height adjustment:	17 positions

Model no.: 53BIHJUV603

Z7 183

THE POWER PACK FOR TOP REQUIREMENTS.



Powered by
Kawasaki

Cutting width:	183 cm
Lawn area (rec.):	18.000 m ² /h
Discharge type:	Side discharge
Engine:	Kawasaki OHV, V-TWIN dual cylinder
Engine displacement:	999 cm ³
Drive:	Dual Hydrostatic
Transmission:	Parker HTG 14 cc
Max. speed:	19,5 km/h (forward)/10 km/h (reverse)
Cutting height adjustment:	17 positions

Model no.: 53AIHKUY603



Z9 183id

MADE FOR SLOPES

Powered by **Kawasaki**

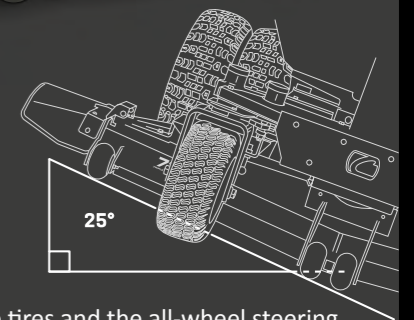

OUTSTANDING MOWING PERFORMANCE

Thanks to the technical equipment, straight mowing lines, zero radius turns and mowing on steep slopes are easy.

WORK EFFICIENTLY AND DRIVE COMFORTABLY

With the comfort features, you can enjoy a relaxed ride throughout the day. With the air ride seat, you can adjust the seat firmness according to your personal preferences.

ELECTRONICALLY ADJUSTABLE CUTTING DECK

Adjust the cutting deck to the specific requirements with just the touch of a button.

CLIMBING ABILITIES

Extremely wide double tires and the all-wheel steering help the stability and precision even on steep slopes with inclines of up to 25°.

POWER AND ECONOMY COMBINED

Thanks to the electronic direct injection, the robust Kawasaki engine combines maximum performance with low fuel consumption.

A RELIABLE PARTNER OVER YEARS

Cub Cadet gives you a warranty of 1.000 working hours or 3 years* on the new Z9 183id. *Whichever comes first



KAWASAKI FX 1000V EFI V-TWIN DUAL CYLINDER

Z9 183id

The Z-Turn Z9 183id is a commercial Zero-Turn mower with extremely wide double tires – developed to tackle steep slopes of up to 25° (46 %). In addition, it has an impressive extremely robust and multi-reinforced steel cutting deck, outstanding mowing performance and air-cushioned seating comfort. This top-of-the-line zero turn is ideal for municipalities, commercial users and owners of large properties with challenging terrain.

Cutting width:	183 cm
Lawn area (rec.):	18.000 m ² /h
Discharge type:	Side discharge
Engine:	Kawasaki FX1000V EFI, V-TWIN dual cylinder
Engine displacement:	999 cm ³
Drive:	Dual Hydrostatic
Transmission:	Parker HTG 16 cc
Max. speed:	19,5 km/h (drive) / 10,0 km/h (reverse)
Cutting height adjustment:	17 positions

Model no.: 53ALHMUY603

Z5 152

Z7 183

ENGINE		
Engine type	Kawasaki OHV	Kawasaki OHV
Engine displacement	852 cm ³	999 cm ³
Rated power	17,2 kW / 2.500 min ⁻¹	21 kW / 2.600 min ⁻¹
Cylinders	V-TWIN dual cylinder	V-TWIN dual cylinder
Tank volume (capacity)	2 x 34 l	2 x 34 l with fuel gauge
Drive	Dual Hydrostatic	Dual Hydrostatic
Transmission	Parker HTG 12 cc	Parker HTG 14 cc
Lubrication	Pressure oil lubrication	Pressure oil lubrication
CUTTING SYSTEM		
Lawn area (rec./up to)	15.000 m ² /h	18.000 m ² /h
Cutting width	152 cm	183 cm
Cutting height (min-max)	26-127 mm	26-127 mm
Cutting options	2-in-1	2-in-1
Number of blades	3	3
Deck engagement	Electric PTO	Electric PTO
Deck height positions	17 positions	17 positions
Deck wheels	4 + 2 front roller	4 + 2 Nose + 1 deck rear rollers
Mulch Kit	Standard	Standard
DISCHARGE SYSTEM		
Ejection type	Side discharge	Side discharge
Grass deflector	Standard	Standard
FRAME		
Front bumper/rear bumper	- / Standard	- / Standard
Turning radius	0 cm	0 cm
Wheel size (f/r in inch)	15 x 6 / 24 x 12	16 x 6,5 / 24 x 12
Wheel bearings	Ball bearings	Ball bearings
ELECTRICAL SYSTEM		
Battery	230 CCA	230 CCA
Headlights	-	-
Hour metre/service minder	Standard	Standard
Safety systems	Rollover bar	Rollover bar
COMFORT		
Seat type	High back with armrests, adjustable	High back with armrests, adjustable
Seat adjustment	Quick adjuster lever	Quick adjuster lever
Steering wheel	Soft-Grip	Soft-Grip
Utility bin	-	-
Mow-in-reverse	Standard	Standard
Battery charger	-	-
DIMENSIONS		
Noise level LpA/LwA/LwAg	93/103/105 dB (A)	93/103/105 dB (A)
Vibration value body/K-Faktor	1,0 / 0,5 m/s ²	1,0 / 0,5 m/s ²
Vibration value hand/arm / K-Faktor	5,0 / 1,5 m/s ²	5,0 / 1,5 m/s ²
Dimensions (L/W/H)	230 / 160 / 134 cm	226 / 185 / 131 cm
Net weight	680 kg	732 kg
Model number	53BIHJUV603	53AIHKUY603
EAN	 4 008423 872415	 4 008423 881929

Z9 183id

ENGINE	
Engine type	Kawasaki FX1000V EFI
Engine displacement	999 cm ³
Rated power	28 kW / 2.600 min ⁻¹
Cylinders	V-TWIN dual cylinder
Tank volume (capacity)	2 x 34 l, with fuel indicator
Drive	Dual Hydrostatic
Transmission	Parker HTG 16 cc
Lubrication	Pressure oil lubrication
CUTTING SYSTEM	
Lawn area (rec./up to)	18.000 m ² /h
Cutting width	183 cm
Cutting height (min-max)	26-127 mm
Cutting options	2-in-1
Number of blades	3
Deck engagement	Electric PTO
Deck height positions	17 positions
Deck wheels	4 + 2 roller
Mulch Kit	Standard
DISCHARGE SYSTEM	
Ejection type	Side discharge
Grass deflector	Standard
FRAME	
Front bumper/rear bumper	- / Standard
Turning radius	0 cm
Wheel size (f/r in inch)	16 x 6,5 / 24 x 12
Wheel bearings	n.a.
ELECTRICAL SYSTEM	
Battery	12 V / 230 CCA
Headlights	-
Hour metre/service minder	Standard
Safety systems	Rollover bar
COMFORT	
Seat type	High back with armrests, individually adjustable
Seat adjustment	Quick adjuster lever
Steering wheel	Soft-Grip
Utility bin	Standard
Mow-in-reverse	Standard
Battery charger	-
DIMENSIONS	
Noise level LpA/LwA/LwAg	93/103/105 dB (A)
Vibration value body/K-Faktor	1,0 / 0,5 m/s ²
Vibration value hand/arm / K-Faktor	5,0 / 1,5 m/s ²
Dimensions (L/W/H)	226 / 185 / 131 cm
Net weight	840 kg
Model number	53ALHMUY603
EAN	 4 008423 917482

PRO SERIES ACCESSORIES

	SNOW CHAINS	
	Snow chains for Z1	0 037049 945603 Mod. no.: 490-241-0026
	Snow chains for Z5 and Z7	0 037049 951123 Mod. no.: 490-241-0036

	DOZER BLADE	
	Dozer blade for Z5 and Z7	0 043033 580255 Mod. no.: 59B30036150

	ELECTRIC DECK LIFT KIT	
	Electric deck lift for Z1	4 008423 881189 Mod. no.: 19B70045100

	LAWN STRIPING KIT	
	Lawn striping Kit for Z1	0 043033 542109 Mod. no.: 19A70019100
	Lawn striping Kit for Z7 and Z9	0 889021 121587 Mod. no.: 59A30052150



ACCESSORIES OVERVIEW

MOD. NO.	DESCRIPTION	EAN CODE	LT1 NR92	LT1 NS92	LT2 NR92	LT2 NS92	LT3 PR105	LT3 PS107	XT1 OR95	XT1 OS96	XT1 OR106	XT1 OS107	XT2 PR95	XT2 QR106	XT2 PR106	XT2 PS107	XT2 PS117	XT2 ES107	XT2 QS117	XT3 QR106	XT3 QS127
LAWN TRACTORS ACCESSORIES																					
REAR ACCESSORIES																					
190-236A000	Transport trailer with plastic tub, max. 159 kg	4008423804331	•	•	•	•	•	•	•	•	•	•	•	•	•	•	•	•	•	•	•
196-506-000	Transport trailer with plastic tub, max. 175 kg	4008423816396	•	•	•	•	•	•	•	•	•	•	•	•	•	•	•	•	•	•	•
190-223B000	Steel transport trailer, max. 159 kg	4016918006894	•	•	•	•	•	•	•	•	•	•	•	•	•	•	•	•	•	•	•
196-507-000	Steel transport trailer, max. 340 kg	4008423804348	•	•	•	•	•	•	•	•	•	•	•	•	•	•	•	•	•	•	•
19A30029100	Rear transport platform for XT Series side discharger system	0043033577132							•		•					•	•	•	•		•
19A30028100	Rear-mount electrical spreader for XT Series side discharger system	4008423875775							•		•					•	•		•		•
196-031B000	Trailer spreader, capacity: 39 kg, spreading width 300 cm	4008423875829	•	•	•	•	•	•	•	•	•	•	•	•	•	•	•	•	•	•	•
196-545-000	Trailer spreader, capacity: 80 kg, spreading width 365 cm	4008423874129	•	•	•	•	•	•	•	•	•	•	•	•	•	•	•	•	•	•	•
196-036-000	Tow broadcast spreader 110 lbs	4008423816310	•	•	•	•	•	•	•	•	•	•	•	•	•	•	•	•	•	•	•
190-537A000	Trailer sprayer, spraying rate 6,8 l/min, capacity 95 l	4008423804430	•	•	•	•	•	•	•	•	•	•	•	•	•	•	•	•	•	•	•
196-543-000	Towed lawn and leaf sweeper, 112 cm	4008423858976	•	•	•	•	•	•	•	•	•	•	•	•	•	•	•	•	•	•	•
190-163A000	Towed lawn and leaf sweeper, 107 cm	4008423807516	•	•	•	•	•	•	•	•	•	•	•	•	•	•	•	•	•	•	•
196-570-600	Electr. grass catcher emptying mechanism for XT Series rear discharge	4008423882025							•		•		•	•	•					•	
PH OEM-190-180A	Dual-bag, 200 l, grass catcher for 96/107 cm LT Series mowing decks	4008423815849		•		•		•		•											
OEMR190-180A	Dual-bag, 200 l, grass catcher for 96 cm XT Series mowing decks	4008423883350							•												
19A30030100	Dual-bag, 200 l, grass catcher for 107/117 cm XT Series mowing decks	4008423879636										•				•	•	•	•		
19A30018100	Triple-bag, grass catcher, 210 l, for 127/137 cm XT Series mowing decks	0037049957286																			•
196-555-603	Anti-dust system for XT Series 320 l grass collection system	4008423875089							•		•		•	•							
196-553-603	Anti-dust system for XT Series 360 l grass collection system	4008423874976																		•	
190-228-000	Lawn roller, width 61 cm, max. weight 114 kg	4008423401264	•	•	•	•	•	•	•	•	•	•	•	•	•	•	•	•	•	•	•
190-229-000	Lawn roller, width 92 cm, max. weight 182 kg	4008423804478	•	•	•	•	•	•	•	•	•	•	•	•	•	•	•	•	•	•	•
190-526-000	Lawn rake, 102 cm working width, 20 tines	4008423804454	•	•	•	•	•	•	•	•	•	•	•	•	•	•	•	•	•	•	•
196-094-000	Tow-Lawn Aerator, 102 cm working width, 10 galvanised aerator stars	4008423896367	•	•	•	•	•	•	•	•	•	•	•	•	•	•	•	•	•	•	•
196-552A000	Deflector for all XT series rear discharge lawnmowers	4008423899641							•		•		•	•	•					•	
196-750A678	Deflector for LT Series rear discharger system	4008423836097	•		•		•														
196-399-000	Rear hitch for LT series with rear discharge	4008423914733	•		•		•														
FRONT ACCESSORIES																					
OEM-190-679	Front bumpers – for all LT Series lawn tractors	4008423917819	•	•	•	•	•	•													
196-564-000	Bull bar bumper for XT Series	4056494171210	•	•	•	•	•	•	•	•	•	•	•	•	•	•	•	•	•	•	•
OEM-190-833	117 cm dozer blade for LT Series	4008423807684	•	•	•	•	•	•													
196-584-000	Installation Kit – for attaching OEM-190-833 in the XT Series	4008423879629							•	•	•	•	•	•	•	•	•	•	•	•	•
196-718-678	Universal rubber lip suitable for all dozer blades	4008423815368	•	•	•	•	•	•													
19A30017OEM	117 cm dozer blade for XT Series	0037049957309	•	•	•	•	•	•	•	•	•	•	•	•	•	•	•	•	•	•	•
19A40024100	Snow thrower for XT Series side discharger	0043033573585							•		•					•	•	•	•		•
19A40045OEM	Snow thrower for XT Series rear discharger	0016918038936							•		•		•	•	•					•	
TIELBÜRGER FOR XT SERIES																					
196-603-000	Front attachment sweeper, 120 cm	4008423883510							•	•	•	•	•	•	•	•	•		•	•	•
196-604-000	Hopper for front attachment sweeper	4008423883527							•	•	•	•	•	•	•	•	•		•	•	•
196-606-000	Premium dozer blade, 125 cm	4008423883534							•	•	•	•	•	•	•	•	•		•	•	•
196-607-000	Wheels for Premium dozer blade	4008423883541							•	•	•	•	•	•	•	•	•		•	•	•
196-601-000	Rapid changer without drive – attachment for front premium dozer blade	4008423883497							•	•	•	•	•	•	•	•	•		•	•	•
196-602-000	Rapid changer without drive – attachment for front attachment sweeper	4008423883503							•	•	•	•	•	•	•	•	•		•	•	•
196-608-000	Drive set rear discharge	4008423885194							•		•		•	•	•					•	
196-609-000	Drive set side discharge	4008423885200							•		•		•	•	•	•	•		•	•	•
196-610-000	Mounting frame rear discharge	4008423885217							•		•		•	•	•					•	
196-611-000	Mounting frame side discharge	4008423885224							•		•		•	•	•	•	•		•	•	•

MOD. NO.	DESCRIPTION	EAN CODE	LT1 NR92	LT1 NS92	LT2 NR92	LT2 NS92	LT3 PR105	LT3 PS107	XT1 OR95	XT1 OS96	XT1 OR106	XT1 OS107	XT2 PR95	XT2 QR106	XT2 PR106	XT2 PS107	XT2 PS117	XT2 ES107	XT2 QS117	XT3 QR106	XT3 QS127
LAWN TRACTORS ACCESSORIES																					
MULCHING																					
OEM-190-116	Mulch Kit (without blades) for model LT1 NS96 and LT2 NS96 (until 2022)	4008423819632						•													
196-749A678	Mulch Kit (without blades)	4008423836080	•		•		•														
196-550-000	Mulch Kit without blade for 106 cm mowing decks	4008423875652									•			•	•					•	
196-551-000	Mulch Kit without blade for 95 cm mowing decks	4008423875669							•				•								
196-560-000	Mulching blade for Mulch Kit (196-550-000)	4008423875683								•				•	•					•	
196-561-000	Mulching blade for Mulch Kit (196-551-000)	4008423875690							•				•								
SNOW CHAINS																					
196-658-699	Snow chains for 20" x 8,0" tyres with adapter	4008423824797		•		•		•		•		•					•	•	•	•	
196-898-699	Snow chains for 18" x 9,5" tyres with adapter	4008423813678	•		•		•														
490-241-0025	Snow chains for 22" x 9", 5" x 12" and 23" x 9", 5" x 12"	0037049945597																			•
ADDITIONAL ACCESSORIES																					
196-721A678	Rear wheels with traction tyres, 18" x 9,5"	4008423816891	•		•		•		•	•	•	•	•	•	•	•	•			•	
196-967-678	Battery charger for LR, LT and XT Series	4008423835694	•	•	•	•	•	•	•	•	•	•	•	•	•	•	•			•	•
2024-U1-0003	Tarpaulin for lawn tractors, size L	4008423806441		•		•															
2024-U1-0004	Tarpaulin for lawn tractors, size XL	4008423823882							•	•	•		•	•	•						

MOD. NO.	DESCRIPTION	EAN CODE	LR1 MS76	LR1 MR76	LR2 NS76	LR2 NR76	LR2 ES76
MINI-RIDER							
196-334-600	Mulch Kit/deflector with blade for 76 cm decks	4008423862829	•	•	•	•	•
196-707-678	Mulch Kit/deflector with blade for 60 cm decks	4008423811797					
19A30014OEM	Dual-bag 115 l grass catcher without blades for 76 cm decks	0043033563029		•		•	•
196-397-000	Rear hitch for LR series with side discharge	4008423914719	•		•		•
196-398-000	Rear hitch for LR series with rear discharge	4008423914726		•		•	

MOD. NO.	DESCRIPTION	EAN CODE	LM1 AP46	LM1 AR46	LM1 CR53	LM1 DP53	LM2 DR46s	LM2 DR46es	LM2 DR53s	LM3 CRC46s	LM3 CR53s	LM3 DR53es	LC3 DP56
LAWN MOWERS													
196-588-678	Mulch Kit for 46 cm mowing decks LM Series	4008423855913	•	•			•	•		•			
196-589-678	Mulchkit for 53 cm mowing decks LM Series, until model year 2020	4008423855920			•	•			•		•	•	
196-590-678	Mulchkit for 53 cm mowing decks LM Series, from model year 2021 onwards	4008423918748			•	•			•		•	•	
1182-WS-0001	10 pcs. of cutting line AF3.20, cut to 3,9 mm x 47 cm length for trimmer	4056494116662											•

MOD. NO.	DESCRIPTION	EAN CODE	XR5 1000	XR5 2000	XR5 3000	XR5 4000
ROBOTIC MOWERS						
MRK0067B	Perimeter wire (650 metres on spool)	7290109391458	•	•	•	•
122-003-603	Installation Kit large (for max. 2.500 m²) 250 m wire, 350 pegs	4008423885163	•	•	•	•
122-002-603	Installation Kit medium (for max. 1.200 m²), 150 m wire, 200 pegs	4008423885156	•	•	•	•
122-001-603	Installation Kit small (for max. 400 m²) 100 m wire, 150 pegs	4008423885149	•	•	•	•
122-085-603	RoboHome for XR5 models	4008423917895	•	•	•	•
122-105-603	Blade kit XR5 models	4008423917901	•	•	•	•



MOD. NO.	DESCRIPTION	EAN CODE	LH5 H60	LH5 HT60	LH5 B60	LH5 C60	LM5 E 51 R
60V MAX* AKKU-SYSTEM							
49AP601-603	60V MAX* battery, 2,5 Ah	4008423917383	•	•	•	•	
49AP602-603	60V MAX* battery, 5,0 Ah	4008423917390					•
49AL601-603	60V MAX* Charger, 2,0 A	4008423917406	•	•	•	•	•

*Maximum initial battery voltage (measured without a workload) is 60 volts. Nominal voltage is 54 volts.



MOD. NO.	DESCRIPTION	EAN CODE	XS2 61 SWE	XS3 66 SWE	XS3 71 SWE	XS3 76 SWE	XS3 76 TDE
WINTER ACCESSORIES							
7011-M6-0010	Shear bolt for all Cub Cadet snow throwers	4008423821871	•	•	•	•	•
2024-U1-0005	Tarpaulin for all Cub Cadet snow throwers	4047427520458	•	•	•	•	•
6012-X1-0040	Winter engine oil, contents: 1.000 ml	4008423821987	•	•	•	•	•
396-004-678	Dozer blade for all 2X and 3X Series snow throwers	4008423811025	•	•	•	•	•
6012-X1-0045	Easy Run fuel stabiliser, 250 ml	4008423852387	•	•	•	•	•
396-005-678	Rubber lip – universal for for dozer blade OEM-190-833 and 19A30017OEM	400842815837	•	•	•	•	•

MOD. NO.	DESCRIPTION	EAN CODE	XZ5 EL107	XZ5 107	XZ5 127	XZ5 137	XZ6 S107	XZ6 S117	XZ6 S127	XZ7 L122	XZ7 L152i	XZ8 S122	XZ8 S1137i
ZERO-TURN ACCESSORIES													
19C70020100	Twin bagger, 200 l, for XZ2 117i	0037049957835											
19A70043100	Twin bagger, 200 l, for XZ2 127	0043033565085											
19A70040100	Triple bagger, 300 l, for XZ3 122	0043033565054											
19A70054100	Cub Cadet RZT Twin Bagger, 107 cm, 230 litres for XZ5 and XZ6 (XZ6 requires the additional weight kit 490-950-C062)	4008423913361	•	•	•	•	•	•					
19A70055100	Cub Cadet RZT Twin Bagger, 127 / 137 cm, 230 litres for XZ5 and XZ6 (XZ6 requires the additional weight kit 490-950-C062)	0037049965410		•	•	•	•	•					
49A70001100	Triple Bagger, 380 l, for XZ7 and XZ8 with 122 cm cutting width (XZ8 requires the additional weight kit 490-950-C062)	4008423917987								•	•	•	•
49A70002100	Triple Bagger, 380 l, for XZ7 and XZ8 with 137 cm or 152 cm cutting width (XZ8 requires the additional weight kit 490-950-C062)	4008423917994								•	•	•	•
490-950-C062	Weight kit for use with the grass catcher of all XZ6 and XZ8 models	0889021302702					•	•	•			•	•
19A70025100	Hitch for all XZ models	0043033565054	•	•	•	•	•	•	•	•	•	•	•

MOD. NO.	DESCRIPTION	EAN CODE	Z5 152	Z7 183	Z9 183id
PRO Z ACCESSORIES					
490-241-0026	Snow chains for Z1	0037049945603			
490-241-0036	Snow chains for Z5 and Z7	0037049951123	•	•	
59B30036150	Dozer blade for Z5 and Z7	0043033580255	•	•	
19B70045100	Electric deck lift for Z1	4008423881189			
19A70019100	Lawn striping Kit for Z1	0043033542109			
59A30052150	Lawn striping Kit for Z7 and Z9	0889021121587	•		•

MOD. NO.	DESCRIPTION	EAN CODE
INDEPENDENT ACCESSORIES		
19B40026100R	Cub Cadet trailers, max. 450 kg	4008423887013
19A40027OEM	Guide handle for trailer	0037049959068
19A40030OEM	Equipment holder for trailer	0037049959082
196-558-603	Fuel canister, 10 litre	4008423877540

